



RX-V995

AV RECEIVER

AMPLI-TUNER AUDIO-VIDEO

**OWNER'S MANUAL
MODE D'EMPLOI**

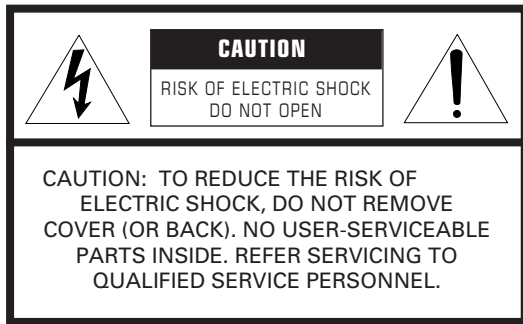

IMPORTANT
 Please record the serial number of your unit in the space below.
 Model:
 Serial No.:
 The serial number is located on the rear of the unit.
 Retain this Owner's Manual in a safe place for future reference.

• Explanation of Graphical Symbols

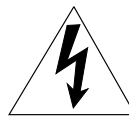

The lightning flash with arrowhead symbol, within an equilateral triangle, is intended to alert you to the presence of uninsulated "dangerous voltage" within the product's enclosure that may be of sufficient magnitude to constitute a risk of electric shock to persons.



The exclamation point within an equilateral triangle is intended to alert you to the presence of important operating and maintenance (servicing) instructions in the literature accompanying the appliance.

WARNING
 TO REDUCE THE RISK OF FIRE OR ELECTRIC SHOCK, DO NOT EXPOSE THIS UNIT TO RAIN OR MOISTURE.

SAFETY INSTRUCTIONS

- 1 Read Instructions – All the safety and operating instructions should be read before the unit is operated.
- 2 Retain Instructions – The safety and operating instructions should be retained for future reference.
- 3 Heed Warnings – All warnings on the unit and in the operating instructions should be adhered to.
- 4 Follow Instructions – All operating and other instructions should be followed.
- 5 Water and Moisture – The unit should not be used near water – for example, near a bathtub, washbowl, kitchen sink, laundry tub, in a wet basement, or near a swimming pool, etc.
- 6 Carts and Stands – The unit should be used only with a cart or stand that is recommended by the manufacturer.
- 6A A unit and cart combination should be moved with care. Quick stops, excessive force, and uneven surfaces may cause the unit and cart combination to overturn. 
- 7 Wall or Ceiling Mounting – The unit should be mounted to a wall or ceiling only as recommended by the manufacturer.
- 8 Ventilation – The unit should be situated so that its location or position does not interfere with its proper ventilation. For example, the unit should not be situated on a bed, sofa, rug, or similar surface, that may block the ventilation openings; or placed in a built-in installation, such as a bookcase or cabinet that may impede the flow of air through the ventilation openings.
- 9 Heat – The unit should be situated away from heat sources such as radiators, stoves, or other appliances that produce heat.
- 10 Power Sources – The unit should be connected to a power supply only of the type described in the operating instructions or as marked on the unit.
- 11 Power-Cord Protection – Power-supply cords should be routed so that they are not likely to be walked on or pinched by items placed upon or against them, paying particular attention to cords at plugs, convenience receptacles, and the point where they exit from the unit.
- 12 Cleaning – The unit should be cleaned only as recommended by the manufacturer.
- 13 Nonuse Periods – The power cord of the unit should be unplugged from the outlet when left unused for a long period of time.
- 14 Object and Liquid Entry – Care should be taken so that objects do not fall into and liquids are not spilled into the inside of the unit.
- 15 Damage Requiring Service – The unit should be serviced by qualified service personnel when:
 - A. The power-supply cord or the plug has been damaged; or
 - B. Objects have fallen, or liquid has been spilled into the unit; or
 - C. The unit has been exposed to rain; or
 - D. The unit does not appear to operate normally or exhibits a marked change in performance; or
 - E. The unit has been dropped, or the cabinet damaged.
- 16 Servicing – The user should not attempt to service the unit beyond those means described in the operating instructions. All other servicing should be referred to qualified service personnel.
- 17 Power Lines – An outdoor antenna should be located away from power lines.
- 18 Grounding or Polarization – Precautions should be taken so that the grounding or polarization is not defeated.

19 For US customers only:

Outdoor Antenna Grounding – If an outside antenna is connected to this unit, be sure the antenna system is grounded so as to provide some protection against voltage surges and built-up static charges. Article 810 of the National Electrical Code, ANSI/NFPA 70, provides information with regard to proper grounding of the mast and supporting structure, grounding of the lead-in wire to an antenna discharge unit, size of grounding conductors, location of antenna discharge unit, connection to grounding electrodes, and requirements for the grounding electrode.

Note to CATV system installer:

This reminder is provided to call the CATV system installer's attention to Article 820-40 of the NEC that provides guidelines for proper grounding and, in particular, specifies that the cable ground shall be connected to the grounding system of the building, as close to the point of cable entry as practical.

EXAMPLE OF ANTENNA GROUNDING

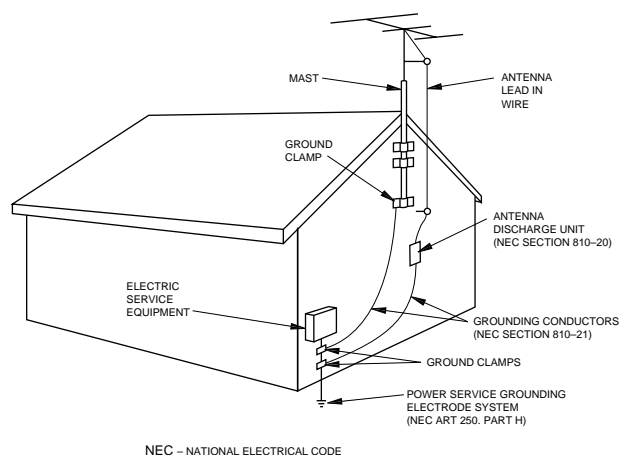
**FCC INFORMATION (for US customers only)****1. IMPORTANT NOTICE : DO NOT MODIFY THIS UNIT!**

This product, when installed as indicated in the instructions contained in this manual, meets FCC requirements. Modifications not expressly approved by Yamaha may void your authority, granted by the FCC, to use the product.

2. IMPORTANT : When connecting this product to accessories and/or another product use only high quality shielded cables. Cable/s supplied with this product MUST be used. Follow all installation instructions. Failure to follow instructions could void your FCC authorization to use this product in the USA.**3. NOTE :** This product has been tested and found to comply with the requirements listed in FCC Regulations, Part 15 for Class "B" digital devices. Compliance with these requirements provides a reasonable level of assurance that your use of this product in a residential environment will not result in harmful interference with other electronic devices.

This equipment generates/uses radio frequencies and, if not installed and used according to the instructions found in the users manual, may cause interference harmful to the operation of other electronic devices.

Compliance with FCC regulations does not guarantee that interference will not occur in all installations. If this product is found to be the source of interference, which can be determined by turning the unit "OFF" and "ON", please try to eliminate the problem by using one of the following measures:

Relocate either this product or the device that is being affected by the interference.

Utilize power outlets that are on different branch (circuit breaker or fuse) circuits or install AC line filter/s.

In the case of radio or TV interference, relocate/reorient the antenna. If the antenna lead-in is 300 ohm ribbon lead, change the lead-in to coaxial type cable.

If these corrective measures do not produce satisfactory results, please contact the local retailer authorized to distribute this type of product. If you can not locate the appropriate retailer, please contact Yamaha Electronics Corp., U.S.A. 6660 Orangethorpe Ave, Buena Park, CA 90620.

The above statements apply ONLY to those products distributed by Yamaha Corporation of America or its subsidiaries.

We Want You Listening For A Lifetime

YAMAHA and the Electronic Industries Association's Consumer Electronics Group want you to get the most out of your equipment by playing it at a safe level. One that lets the sound come through loud and clear without annoying blaring or distortion – and, most importantly, without affecting your sensitive hearing.

Since hearing damage from loud sounds is often undetectable until it is too late, YAMAHA and the Electronic Industries Association's Consumer Electronics Group recommend you to avoid prolonged exposure from excessive volume levels.



Congratulations!

You are the proud owner of a Yamaha Digital Sound Field Processing (DSP) System—an extremely sophisticated audio component. The DSP system takes full advantage of Yamaha's undisputed leadership in the field of digital audio processing to bring you a whole new world of listening experiences. Follow the instructions in this manual carefully when setting up your system, and the DSP system will sonically transform your room into a wide range of listening environments—anything from a famous concert hall to a cozy jazz club. In addition, you get incredible realism from most of surround-sound encoded video sources available in the market using the built-in Dolby Pro Logic Surround Decoder, Dolby Digital Decoder and DTS Decoder.

Five built-in channels of amplification on this model mean that no additional amplifiers are required to enjoy advanced digital sound field processing.

Rather than tell you about the wonders of digital sound field processing, however, let's get right down to the business of setting up the system and trying out its many capabilities. Please read this operation manual carefully and store it in a safe place for later reference.

CONTENTS

SAFETY INSTRUCTIONS Inside of the Front Cover	
CAUTION	2
INTRODUCTION	3
Features	3
What's DSP?	4
GETTING STARTED	7
Getting started	7
Unpacking	7
Installing batteries in the remote controller	8
Notes about the remote controller.....	8
Controls and their functions	9
Front panel.....	9
Display panel.....	11
PREPARATION	12
Speaker setup	12
Connections	14
Audio/video source equipment	14
Speakers	22
Antennas	25
Plugging in this unit	27
On screen display	28
Selecting the output modes (“SET MENU” mode)	29
Speaker balance adjustment	32
BASIC OPERATION	35
Playing a source	35
Recording a source to tape (or MD) or dubbing from tape (or MD) to tape (or MD).....	40
Sound control.....	42
Tuning	43
Basic operation	43
Preset tuning.....	44
Using digital sound field processor (DSP)	47
Playing a source with an effect of the digital sound field processor (DSP)	47
Adjusting output level of the center, right rear, left rear speakers and subwoofer.....	50
Brief overview of digital sound field programs.....	52
ADVANCED FEATURES	56
“SET MENU” mode	56
Creating your own sound fields	60
Setting the SLEEP timer	65
REMOTE CONTROLLER	66
Basic operation (Cover is open)	66
Using the “learning-capable” keys (Cover is open).....	68
Using OPERATION CONTROL keys (Cover is closed)	70
Macro operations (Cover is closed)	72
Methods of learning and clearing functions	74
CUSTOM INSTALLATION GUIDE	77
TROUBLESHOOTING	79
SPECIFICATIONS	82

CAUTION : Read this before operating your unit.

1. To assure the finest performance, please read this manual carefully. Keep it in a safe place for future reference.
2. Install this unit in a cool, dry, clean place – away from windows, heat sources, sources of excessive vibration, dust, moisture and cold. Avoid sources of humming (transformers, motors). To prevent fire or electrical shock, do not expose the unit to rain or water.
3. Never remove the unit cover. Contact your dealer if an object falls inside the unit.
4. Do not use force on switches, controls or connection wires. When moving the unit, first disconnect the power plug and the wires connected to other equipment. Never pull on the wires themselves.
5. The openings on the unit cover assure proper ventilation of the unit. If these openings are obstructed, the temperature inside the unit will rise rapidly. Therefore, avoid placing objects against these openings, and install the unit in a well-ventilated area to prevent fire and damage.

<Singapore model>

Be sure to allow a space of at least 10 cm behind, 20 cm on the both sides and 35 cm above the top panel of the unit to prevent fire and damage.

6. The voltage used must be the same as that specified on this unit. Using this unit with a higher voltage than specified is dangerous and may result in fire or other accidents. YAMAHA will not be held responsible for any damage resulting from use of this unit with a voltage other than specified.
7. Digital signals generated by this unit may interfere with other equipment such as tuners, receivers or TVs. Move this unit farther away from such equipment if interference is observed.
8. Always set the VOLUME control to “-∞” before starting the audio source play. Increase the volume gradually to an appropriate level after playback has been started.
9. Do not attempt to clean the unit with chemical solvents; this might damage the finish. Use a clean, dry cloth.
10. Be sure to read the “TROUBLESHOOTING” section regarding common operating errors before concluding that the unit is faulty.
11. When not planning to use this unit for long periods of time, disconnect the AC power plug from the wall outlet.
12. To prevent lightning damage, disconnect the AC power plug and antenna cable when there is an electrical storm.
13. Grounding or polarization – Precautions should be taken so that the grounding or polarization of an appliance is not defeated.
14. Do not connect an audio unit to the AC outlet on the rear panel if the equipment requires more power than the outlet is rated to provide.
15. **Voltage Selector (China and General Models only)**
The voltage selector on the rear panel of this unit must be set for your local main voltage BEFORE plugging into the AC main supply.
Voltages are 110/120/220/240 V AC, 50/60 Hz.

This unit is not disconnected from the AC power source as long as it is connected to the wall outlet, even if this unit itself is turned off. This state is called the standby mode. In this mode, this unit is designed to consume a small amount of power.

FREQUENCY STEP switch (China and General Models only)

Because the interstation frequency spacing differs in different areas, set the FREQUENCY STEP switch (located at the rear) according to the frequency spacing in your area. Before setting this switch, disconnect the AC power plug of this unit from the AC outlet.

For Canadian Customers

To prevent electric shock, match wide blade of plug to wide slot and fully insert.

This Class B digital apparatus complies with Canadian ICES-003.

WARNING

Do not change the IMPEDANCE SELECTOR switch setting while the power to this unit is on, otherwise this unit may be damaged.

IF THIS UNIT FAILS TO TURN ON WHEN THE STANDBY/ON SWITCH IS PRESSED:

The **IMPEDANCE SELECTOR** switch may not be set to either end. If so, set the switch to either end when this unit is in the standby mode.

IMPEDANCE SELECTOR

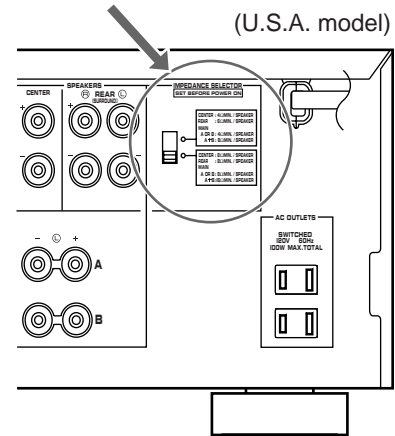

INTRODUCTION

Features

5 Channel Power Amplification

- Main:** 100W + 100W (8Ω) RMS Output Power, 0.04% THD, 20–20,000 Hz
- Center:** 100W (8Ω) RMS Output Power, 0.07% THD, 20–20,000 Hz
- Rear:** 100W + 100W (8Ω) RMS Output Power, 0.07% THD, 20–20,000 Hz

Multi-Mode Digital Sound Field Processing

- Digital Sound Field Processor (DSP)
- Dolby Digital Decoder
- Dolby Pro Logic Surround Decoder
- DTS Decoder
- CINEMA DSP: Theater-like Sound Experience by the Combination of YAMAHA DSP Technology and Dolby Digital, Dolby Pro Logic or DTS
- Automatic Input Balance Control for Dolby Pro Logic Surround
- Test Tone Generator for Easier Speaker Balance Adjustment
- Speaker Output Mode Selection Capability for the Most Suitable Use of Your Speaker System

Sophisticated FM/AM Tuner

- 40-Station Random Access Preset Tuning
- Automatic Preset Tuning
- Preset Station Shifting Capability (Preset Editing)
- IF Count Direct PLL Synthesizer Tuning System

Others

- “SET MENU” Mode which Provides You with 13 Titles of Setting Changes and Adjustments for Optimizing This Unit for Your Audio/Video System
- BASS EXTENSION Button for Reinforcing Bass Response
- On Screen Display Function Helpful in Controlling This Unit
- REC OUT Selector which is Independent of Input Source Selection
- SLEEP Timer
- OPTICAL and COAXIAL Digital Audio Signal Terminals
- 6 Channel External Decoder Input for Other Future Formats
- Video Signal Input/Output Capability (Including S Video Connections)
- Multi-Functional remote controller with “Learning” Capability
- Dual-Room Audio/Video System Setup Capability (Custom Installation)

What's DSP?

Introduction

Welcome to the exciting world of digital home entertainment. This unit is one of the most complete and advanced AV receiver available. Some of the more advanced features may not be familiar to you, but they are easy to use. State-of-the-art technologies such as Dolby Digital and Digital Theater Systems (DTS) may be new to your home, but you have probably experienced the amazing realism they bring to feature films in theaters around the world.

To make the listening experience even more enjoyable, this unit includes a number of exclusive, digitally created listening environments known as digital sound fields. Choosing a sound field program is like transporting yourself to such venues as an outdoor arena, a European church, or a cozy jazz club. Take some time now to read more about these features and enjoy the new experiences this unit brings to your home theater.

Digital Sound Field Processing

Technological advances in sound reproduction over the last 30 years have enhanced the listening experience with improved clarity, precision and power. However, something has still been missing: The atmosphere and acoustic ambience of the public venue. Our Yamaha engineers have extensively researched the nature of sound acoustics and the way sound reflects inside a room. We sent these engineers to famous theaters and concert halls around the world to measure the acoustics of those venues with sophisticated microphones. The data they collected is used to recreate these environments in digital sound fields. Some of these digital sound fields are created using data measured directly at the original venue; others are created from combinations of data to form unique environments for specific purposes.

Of course, that only solves half of the problem. These engineers have no way of knowing the acoustics of your listening room, so we've made it possible for you to adjust the various parameters of this data to tailor each virtual venue to your taste. You can use these sound fields to enhance any source and in combination with any of the following surround sound technologies. Some are designed especially for music, and some especially for movies.

Dolby Pro Logic Surround

Dolby Pro Logic Surround has been used in movie theaters since the mid-seventies. It has also been available in home entertainment systems since the late eighties and continues to be a popular format for home theater systems. It uses four discrete channels and five speakers to reproduce realistic and dynamic sound effects: two main channels (left and right), a center channel for dialog, and a rear channel for special sound effects. The rear channel reproduces sound within a narrow frequency range.

Most video tapes and laser discs include Dolby Pro Logic Surround encoding as do many TV and cable broadcasts. The Dolby Pro Logic Surround decoder built into this unit employs a digital signal processing system that stabilizes each channel for even more accurate sound positioning than is available with standard analog processors.

Dolby Digital

Dolby Digital is the next level of Dolby Surround sound system developed for 35 mm film-movies by employing low bit-rate audio coding.

Dolby Digital is a digital surround sound system that provides completely independent multi-channel audio to you. Dolby Digital provides five full range channels in what is sometimes referred to as a "3/2" configuration: three front channels (left, center and right), and two surround channels. A sixth bass-only effect channel is also provided for output of LFE (low frequency effect), or low bass effects that are independent of other channels. (This is called the "subwoofer channel" or "LFE channel".) This channel is counted as 0.1, thus giving rise to the term 5.1 channels in total.

Compared to Dolby Pro Logic that is referred to a "3/1" system (left front, center, right front and just one surround channel), Dolby Digital features two surround channels, called stereo or split surrounds, each offering the same full range fidelity as the three front channels.

By using the built-in Dolby Digital decoder, you can experience the dramatic realism and impact of Dolby Stereo Digital theater sound in your home.

Wide dynamic range of sound reproduced by the five full range channels and precise sound orientation by the digital sound processing presents listeners much excitement and realism that has never been experienced before.

Dolby Digital forms 5.1 channels as mentioned left, and moreover, it can also form fewer channels, for example 2 channel stereo and monaural. You may be able to find some 2 channel stereo and/or monaural sources encoded with Dolby Digital in the market.

Laserdisc and DVD are home audio formats that could benefit from Dolby Digital. In the near future, Dolby Digital will also be applied to DBS, CATV and HDTV. The ongoing release of Dolby Stereo Digital theatrical films now underway will provide an immediate source of Dolby Digital encoded video software.



Manufactured under license from Dolby Laboratories Licensing Corporation. "DOLBY", "AC-3", "Pro Logic", and the double-D symbol are trademarks of Dolby Laboratories Licensing Corporation.

Copyright 1992 Dolby Laboratories, Inc. All rights reserved.

DTS Digital Surround

DTS (Digital Theater Systems) system was developed to replace analog soundtracks of movies with six discrete channels of digital soundtracks, and now, it is installed in many theaters around the world. The DTS digital playback system changed the way we experienced movies in theaters with six discrete channels of superb digital audio.

The DTS technology, through intense research and development, made it possible to deliver a similar encode/decode discrete technology to home audio surround-sound entertainment.

The DTS Digital Surround is an encode/decode system which delivers six channels of master-quality, 20-bit audio; technically 5.1 channels, which means 5 full-range (left, center, right and two surround) channels, plus a subwoofer (LFE) channel (as "0.1"). It is compatible with the 5.1 speaker configurations that are currently available for home theater systems

The DTS Digital Surround algorithm is designed to encode the six channels of 20-bit audio onto some laserdiscs, compact discs and DVDs with considerably less data-compression.

By using the DTS decoder built into this unit, you can experience the dramatic realism and impact of the DTS installed theater's high quality sound in your home.

Laserdisc, compact disc and DVD are home audio format within which DTS can represent its high quality multi-channel audio. (In addition to movies on laserdiscs, many exciting new multi-channel music recordings will also become available in the form of DTS-encoded compact discs.)



Manufactured under license from Digital Theater Systems, Inc. US Pat. No. 5,451,942 and other world-wide patents issued and pending. "DTS", "DTS Digital Surround", are trademarks of Digital Theater Systems, Inc. Copyright 1996 Digital Theater Systems, Inc. All Rights Reserved.

CINEMA DSP: Dolby Surround + DSP / DTS + DSP

The Dolby Surround sound and DTS systems show their full ability in a large movie theater, because movie sounds are originally designed to be reproduced in a large movie theater that uses a multitude of speakers. Trying to create a sound environment similar to that of a movie theater in your home is difficult because of the room size, material inside the walls, the number of speakers, and so on. In other words, your listening room is very different from a movie theater.

However, Yamaha DSP technology allows you to create nearly the same sound experience as that of a large movie theater in your home by compensating for the lack of presence and dynamics in the listening room with original digital sound fields combined with Dolby Surround or DTS Digital Surround sounds.

CINEMA DSP

The YAMAHA "CINEMA DSP" logo indicates those programs that are created by the combination of YAMAHA DSP technology and Dolby Surround or DTS.

Dolby Pro Logic + 2 Digital Sound Fields

Digital sound fields are created on the presence side and the rear surround side of the Dolby Pro Logic Surround-decoded sound field respectively. They create a wide acoustic environment and emphasize surround-effect in the room, letting you feel much presence as if you were watching a movie in a popular Dolby Stereo theater.

This combination is available when the digital sound field program No. 6, 7, 8, 9 or "PRO LOGIC/Enhanced" of No. 10 is selected, and the input signal of the source is analog, PCM audio or encoded with the Dolby Digital in 2-channels.

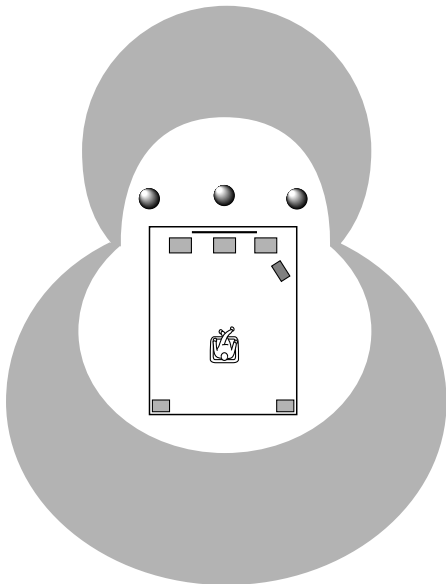

Dolby Digital or DTS + 3 Digital Sound Fields

Digital sound fields are created on the presence side and the independent left and right surround sides of the Dolby Digital-decoded or the DTS-decoded sound field respectively. They create a wide acoustic environment and much surround effect in the room without losing high channel separation. With wide dynamic range of Dolby Digital or DTS sound, this sound field combination lets you feel as if you were watching a movie in the newest Dolby Stereo Digital theater or DTS installed theater. This is the most ideal home theater sound at the present time.

This combination is available when the digital sound field program No. 6, 7, 8, 9 or "DOLBY DIGITAL (or DTS DIGITAL SUR.)Enhanced" of No. 10 is selected, and the input signal of the source is encoded with the Dolby Digital (except in 2-channels) or encoded with the DTS.

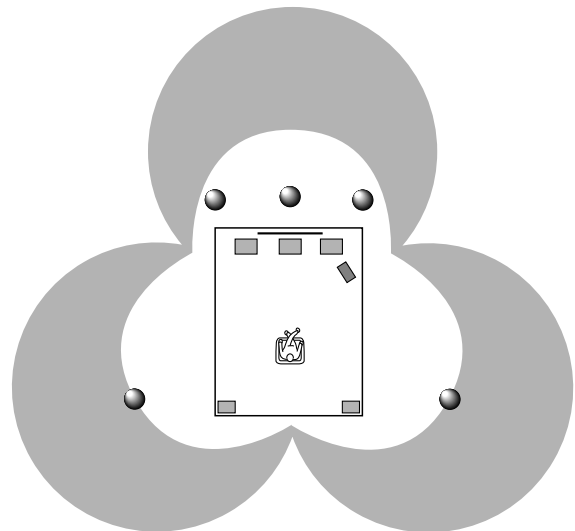

GETTING STARTED

Getting started

Unpacking

Carefully remove this unit and accessories from the box. You should find the unit itself and the following accessories.

Remote controller

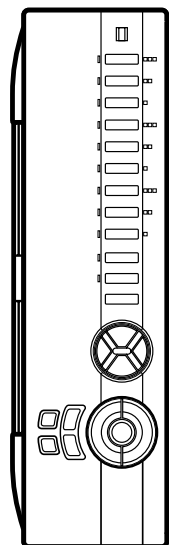

Indoor FM Antenna

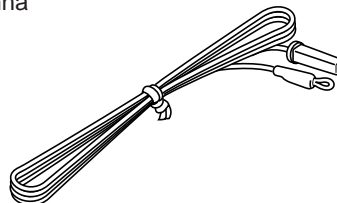

AM Loop Antenna

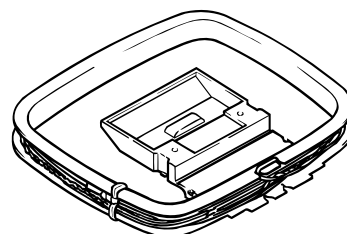

Antenna adapter (U.S.A. and Canada models only)

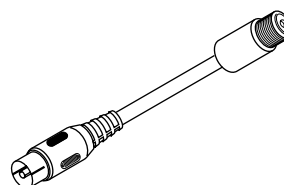

User function stickers

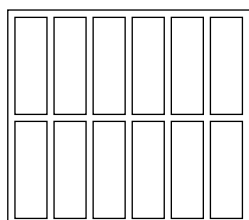

Batteries (size AA, LR6, UM-3)

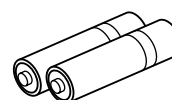

Installing batteries in the remote controller

Since the remote controller will be used for many of this unit's control operations, you should begin by installing the supplied batteries.

1. Turn the remote controller over and slide the battery compartment cover in the direction of the arrow.
2. Insert the batteries (AA, LR6, UM-3 type) according to the polarity markings on the inside of the battery compartment.
3. Close the battery compartment cover.

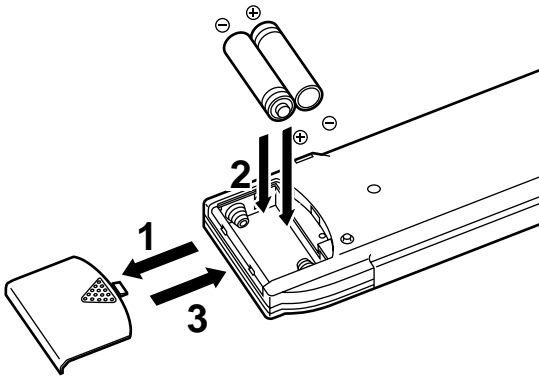

4. After the batteries are inserted, press the **RESET** button before using the remote controller.

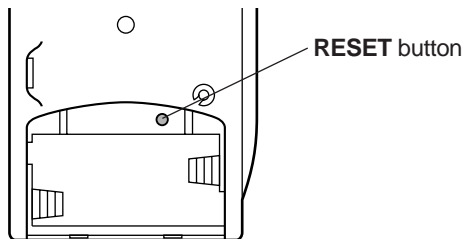

Notes about the remote controller

Battery replacement

If you find that the remote controller must be used closer to the main unit, the batteries are weak. Replace both batteries with new ones.

Notes

- Use only AA, R6, UM-3 batteries.
(It is recommended to use an LR6 type to use the remote controller for a long period of time.)
- Be sure the polarities are correct. (See the illustration inside the battery compartment.)
- Remove the batteries if the remote controller is not used for an extended period of time.
- If batteries leak, dispose of them immediately. Avoid touching the leaked material and contact with clothing, etc. Clean the battery compartment thoroughly before installing new batteries.

Remote controller operation range

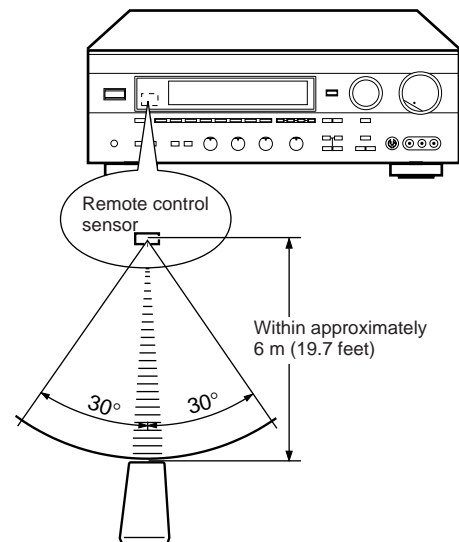

Notes

- The area between the remote controller and the main unit must be clear of large obstacles.
- Do not expose the remote control sensor to strong lighting, in particular, an inverter type fluorescent lamp. Otherwise, the remote controller may not work properly. If necessary, position the main unit away from direct lighting.

Controls and their functions

Front panel

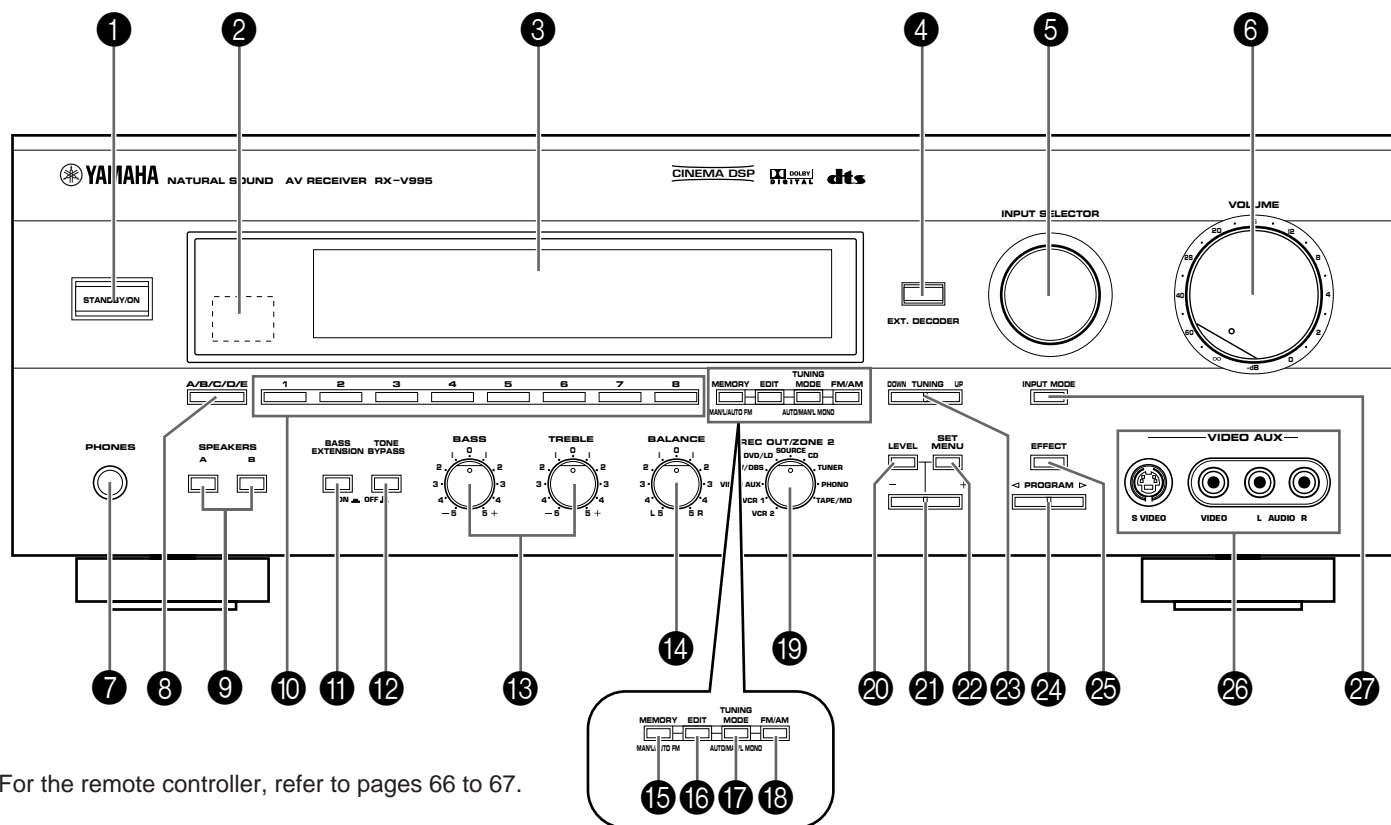

For the remote controller, refer to pages 66 to 67.

1 STANDBY/ON switch

Press this switch to turn on the power. Press this switch again to set this unit in the standby mode.

* A click from the switch and the initial rotation of the built-in fan will be heard when the power is turned on.

Standby mode

This unit is still using a small amount of power in this mode in order to be ready to receive infrared-signals from the remote controller.

2 Remote control sensor

Receives signals from the remote controller.

3 Display panel

Displays a variety of information. (Refer to page 11 for details.)

4 EXT. DECODER button

Press this button to select the input signals from the EXTERNAL DECODER INPUT terminals as the input source. This function takes priority over the **INPUT SELECTOR** setting. "EXT. DECODER" will be illuminated on the display panel.

The source selected with the **INPUT SELECTOR** knob becomes the current input source when "EXT. DECODER" is not illuminated on the display panel.

5 INPUT SELECTOR

Turn this knob to select the input source. The selected source will be shown on the display.

6 Master VOLUME control

Simultaneously controls volume for all output sounds; front effect, main, rear, center and subwoofer. (The REC OUT level is not affected.)

* The indicator on the master **VOLUME** control will flash when the volume is decreased by pressing the **MUTE** key on the remote controller.

7 PHONES jack

Headphones can be plugged into this jack for private listening. You can listen to the sound to be output from the main speakers through headphones. When listening with headphones privately, press both **SPEAKERS A** and **B** switches to cancel both of the main speakers A and B, and turn off the digital sound field processor by pressing the **EFFECT** button so that no DSP program name is illuminated on the display panel.

PHONES

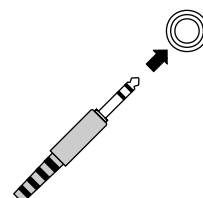

8 A/B/C/D/E button

Press this button to select a group (A–E) of preset stations.

9 SPEAKERS switches

Press the switch A or B (or both) for the main speakers you will use to select them. Press the switch for the main speakers you will not use again to cancel them. On the display panel, “SPEAKERS A” and/or “SPEAKERS B” will be illuminated, depending on which main speakers are being selected.

10 Preset station number selector buttons

Select a preset station number (1 to 8).

11 BASS EXTENSION button

Press this button inward (ON) to boost the bass frequency response at the main left and right channels while maintaining overall tonal balance. This function is effective for reinforcing the bass frequencies when a subwoofer is not used.

12 TONE BYPASS button

Press this button inward (ON) to bypass the tone (BASS and TREBLE) control circuitry. This function is used for outputting pure sound and checking the tone control settings. The tone control circuitry can be used when this button is released outward (OFF).

13 BASS and TREBLE controls

Rotate these knobs to adjust the low and high frequency response for the left and right main channels only.

14 BALANCE control

This knob controls the sound from the main speakers only. The balance of the output volume to the left and right main speakers can be adjusted to compensate for sound imbalances caused by the speaker location or listening room conditions.

15 MEMORY (MAN'L/AUTO FM) button

Use this button to enter a station to memory. Refer to the section “Manual preset tuning” on page 44 for details. Hold down this button for more than 3 seconds to start automatic preset tuning. Refer to page 45 for details.

16 EDIT button

This button is used to exchange the places of two preset stations with each other.

17 TUNING MODE (AUTO/MAN'L MONO) button

Press this button to switch the tuning mode between automatic and manual. To select the automatic tuning mode, press this button so that the “AUTO” indicator is illuminated on the display. To select the manual tuning mode, press this button so that the “AUTO” indicator is not illuminated.

18 FM/AM button

Press this button to switch the reception band between FM and AM.

19 REC OUT/ZONE 2 selector

Rotate this knob to select the source for recording to an MD recorder (or tape deck) or VCR. This setting is independent of the **INPUT SELECTOR** setting, except when the **REC OUT/ZONE 2 selector** is set to the SOURCE position. Then the **INPUT SELECTOR** is used to select the source for recording to the MD recorder (or tape deck) or VCR.

For a user who made up a dual-room audio/video system with this unit:

The setting of the **REC OUT/ZONE 2 selector** controls the input source for the second room.

20 LEVEL button

This button is used to adjust the output level of the center and rear speakers, and subwoofer. First, press this button (several times) to select the speaker(s). The name appears on the display. Then press the + or – button (21) to change the output level.

21 –/+ button

Adjusts the level of the speaker(s) selected by pressing the **LEVEL** button. Moreover, performs setting changes and adjustments for functions selected by pressing the **SET MENU** button (22).

22 SET MENU button

Press this button once or more to select the desired function in the SET MENU mode.

23 TUNING DOWN/UP button

Used for tuning. Press the “UP” side to tune in to a higher frequency, and press the “DOWN” side to tune in to a lower frequency.

24 PROGRAM selector button

Press this button in the ◀ or ▶ direction to select a digital sound field processing program.

25 EFFECT button

Press this button to turn on and off the output from the center and rear speakers. The sound becomes normal 2-channel when this function is turned off. However, this does not apply to Dolby Digital or DTS. The signals at all channels will be distributed to the main channels and output from the main speakers, even if the output from the center and rear speakers are turned off, when Dolby Digital or DTS is decoded.

26 VIDEO AUX terminals

Connect an auxiliary video or audio input source unit such as a camcorder to these terminals. A video unit with a S video output terminal can be connected to the S VIDEO terminal to obtain a high resolution picture. The source can be selected with the **INPUT SELECTOR** and **REC OUT/ZONE 2 selector**.

27 INPUT MODE button

Press this button to select how input signals are received from sources that output two or more types of signals. The “AUTO”, “DTS” and “ANALOG” modes are available. Refer to page 38 for details.

<China, Singapore and General models only>

The “AUTO”, “D.D.RF”, “DTS”, “DGTL” and “ANALOG” modes are available for DVD/LD sources.

Display panel

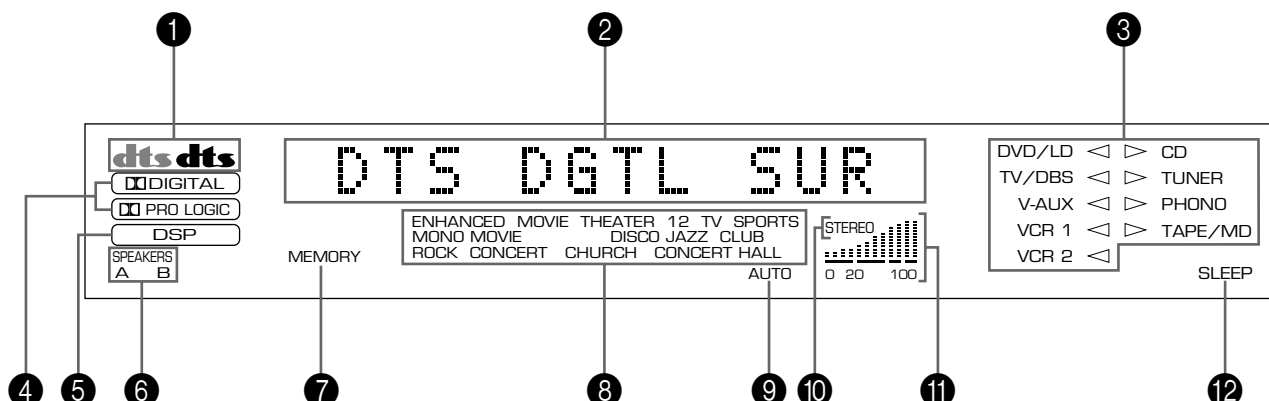

1 dts indicators

Either “dts” indicators will be illuminated when the built-in DTS decoder is turned on.
 A red “dts” indicator will be illuminated when playing a compact disc or laserdisc encoded with DTS.
 An orange “dts” indicator will be illuminated when playing a DVD encoded with DTS.
 An orange “dts” indicator may be illuminated when playing a laserdisc encoded with DTS after a video-CD or DVD on a DVD/LD combi-player.

2 Multi-information display

This display shows the current DSP program and the status of adjustments and setting changes. Several statuses can be viewed at one time. The current station frequency and band (AM or FM) will also appear when the tuner source input mode is selected.

3 Input source indicators

One of the arrows for these indicators will be illuminated depending on which source is selected.

4 DIGITAL and PRO LOGIC indicators

The DIGITAL indicator will be illuminated when the built-in Dolby Digital decoder is on and the signals of the source encoded with Dolby Digital are not 2-channels.
 The PRO LOGIC indicator will be illuminated when the built-in Dolby Pro Logic Surround decoder is on.

5 DSP indicator

This indicator will be illuminated when the built-in digital sound field processor is on.

6 SPEAKERS A/B indicators

One of these indicators will be illuminated depending on which main speakers are selected. Both indicators will be illuminated when both speakers A and B are selected.

7 MEMORY indicator

A flashing MEMORY indicator means a station can be saved, as explained in the following:
 Press the **MEMORY** button. The MEMORY indicator will flash about 5 seconds. While the indicator is flashing, program the displayed station to memory by using the **A/B/C/D/E** and the **preset station number selector** buttons.

8 DSP program indicators

The name of the selected DSP program will be illuminated in the following cases.

- When the tuner is selected as the input source.
- When a DSP program parameter is selected or adjusted.
- When the DSP program No. 8, 9 or the subprogram “Enhanced” of No. 10 is selected.

There is no illumination here when no DSP program is selected

9 AUTO indicator

This indicator will be illuminated during the automatic tuning mode.

10 STEREO indicator

This indicator will be illuminated when an FM stereo broadcast with sufficient signal strength is received.

11 Signal-level indicator

This indicator shows the signal level of the received station. If multipath interference is detected, the indication decreases.

12 SLEEP indicator

This indicator will be illuminated when the built-in SLEEP timer is on.

PREPARATION

Speaker setup

■ Setting up your speaker system

This unit has been designed to provide the best sound field quality with a full five-speaker system setup, using a pair of main speakers to output main source sounds, a pair of effect speakers to generate the sound field plus one center speaker for dialog. We therefore recommend that you use a five-speaker setup. A four-speaker system using only one pair of effect speakers for the sound field will still provide impressive ambience and effects, however, and may be a good way to begin with this unit. You can always upgrade to the five-speaker system later.

Use of the center dialog speaker is recommended

When playing back a source with Dolby Pro Logic decoded, or playing back a source which contains center-channel signals with Dolby Digital or DTS decoded, dialog, vocals etc. are output from the center channel. Therefore, if you want to maximize the performance of your Audio/Video home theater system, it is recommended that you use a center channel speaker.

If, for some reason, it is not practical to use a center speaker, it is possible to enjoy the movie without it. Best results, however, are obtained with the full system.

Use of a subwoofer expands your sound field

It is also possible to further expand your system with the addition of a subwoofer and amplifier. The use of a subwoofer is effective not only for reinforcing bass frequencies from any or all channels, but also for reproducing signals at the subwoofer channel with high fidelity during playing back a source with Dolby Digital or DTS decoded. You may wish to choose the convenience of a Yamaha Active Servo Processing Subwoofer System, which has its own built-in power amplifier.

■ Speakers and speaker placement

Your full five-speaker system will require two speaker pairs: the MAIN SPEAKERS (your normal stereo speakers) and the REAR SPEAKERS, plus the CENTER SPEAKER. You may also be using a SUBWOOFER.

The MAIN SPEAKERS should be high performance models and have enough power handling capacity to accept the maximum output of your audio system.

Other speakers do not have to be equal to the MAIN SPEAKERS. For precise sound localization, however, it is ideal to use high performance models that can reproduce sounds in full range for the CENTER SPEAKER and REAR SPEAKERS.

Place the MAIN SPEAKERS in the ordinary position.

Place the REAR SPEAKERS behind your listening position.

They should be nearly 1.8m above the floor.

Place the CENTER SPEAKER precisely between the two MAIN SPEAKERS. (To avoid interference, keep the speaker above or below the television monitor, or use a magnetically shielded speaker.)

If using a SUBWOOFER, such as a Yamaha Active Servo Processing Subwoofer System, the position of the speaker is not so critical because low bass tones are not highly directional.

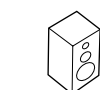
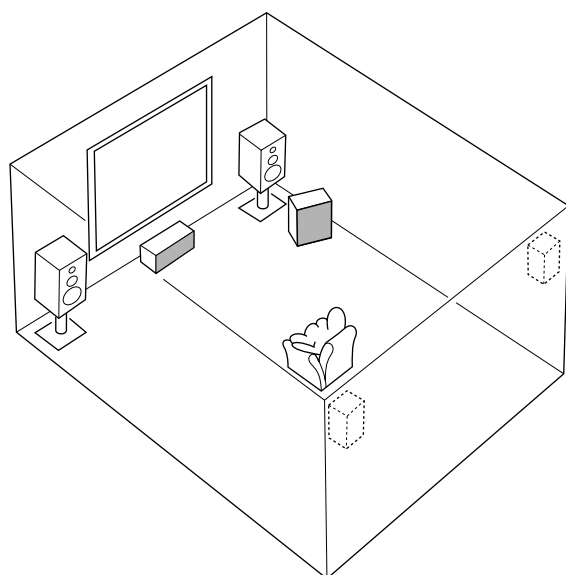

Main speaker



Center speaker



Rear speaker



Subwoofer

■ Speaker system configurations

5 Speaker System

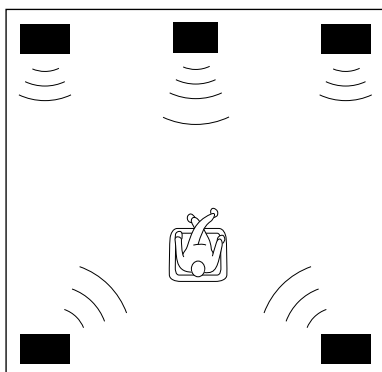

The recommended system for enjoying Audio/Video sources.

By the use of a center speaker, center channel sounds (dialog, vocals etc.) are precisely localized.

-
1. CENTER SPEAKER—Set to “LRG” or “SML”.
(See page 29.)

4 Speaker System

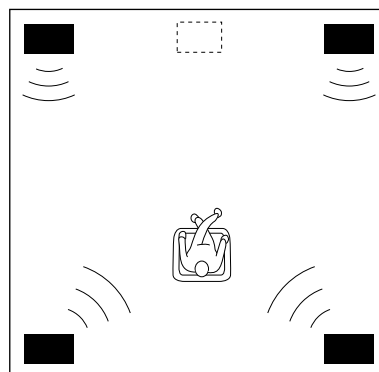

Basic system.

You can enjoy widely diffused sound by only adding a pair of rear speakers to a basic stereo speaker system. However, center channel sounds must be output from the left and right main speakers.

-
1. CENTER SPEAKER—Set to “NONE”. (See page 29.)

Connections

Caution: Plug in this unit and other components after all connections are completed.

All connections must be correct, that is to say L (left) to L, R (right) to R, “+” to “+” and “-” to “-”. Also refer to the owner’s manual for each of your components.

Audio/video source equipment

- Use RCA type pin plug cables for audio/video units with the exception described later.
- The output (or input) terminals of YAMAHA audio/video units numbered as 1, 3, 4, etc. on the rear panel must be connected to the same-numbered terminals of this unit.

Basic connections of audio units

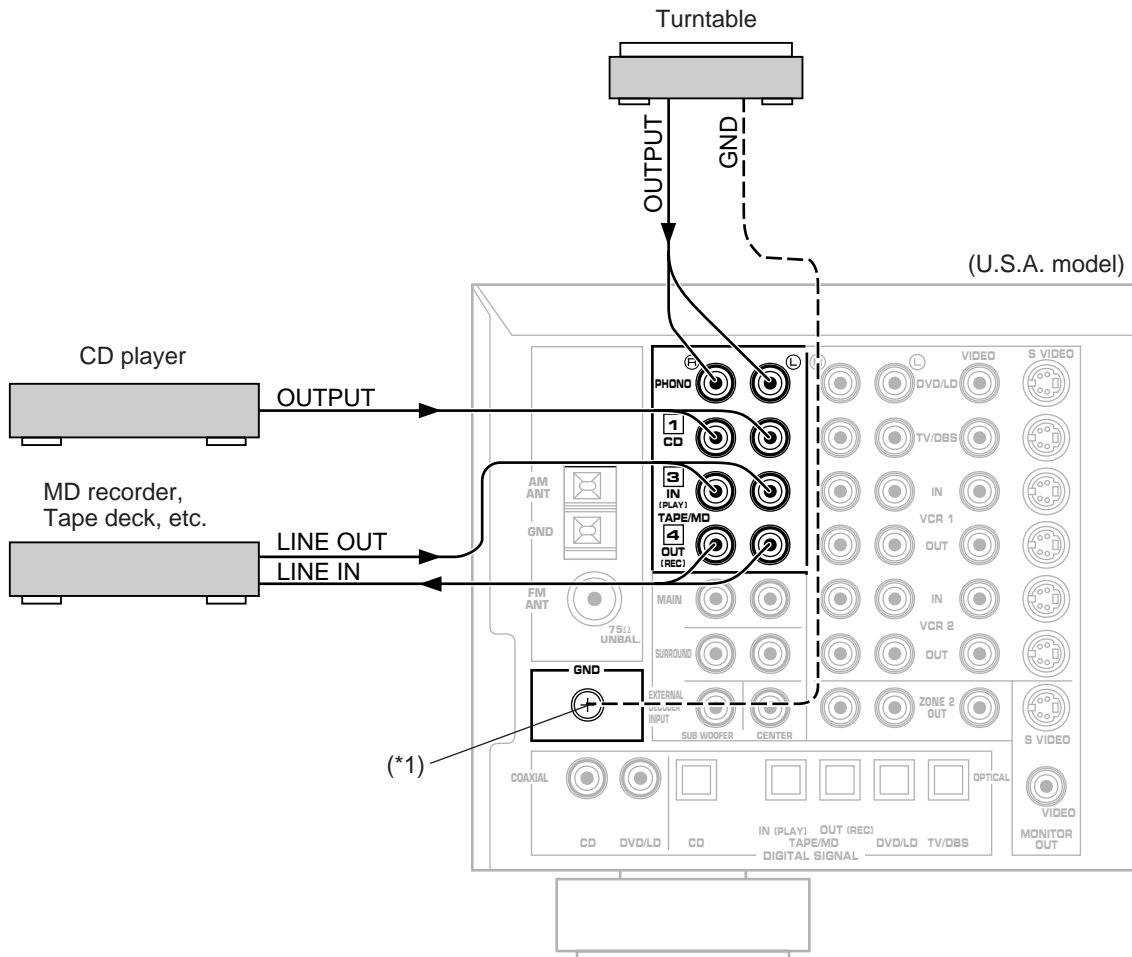

(*1): **GND terminal (For turntable use)**

Connecting the ground wire of the turntable to the **GND** terminal will normally minimize hum, but in some cases better results may be obtained with the ground wire disconnected.

➔ : Indicates the direction of signals.

Basic connections of video units

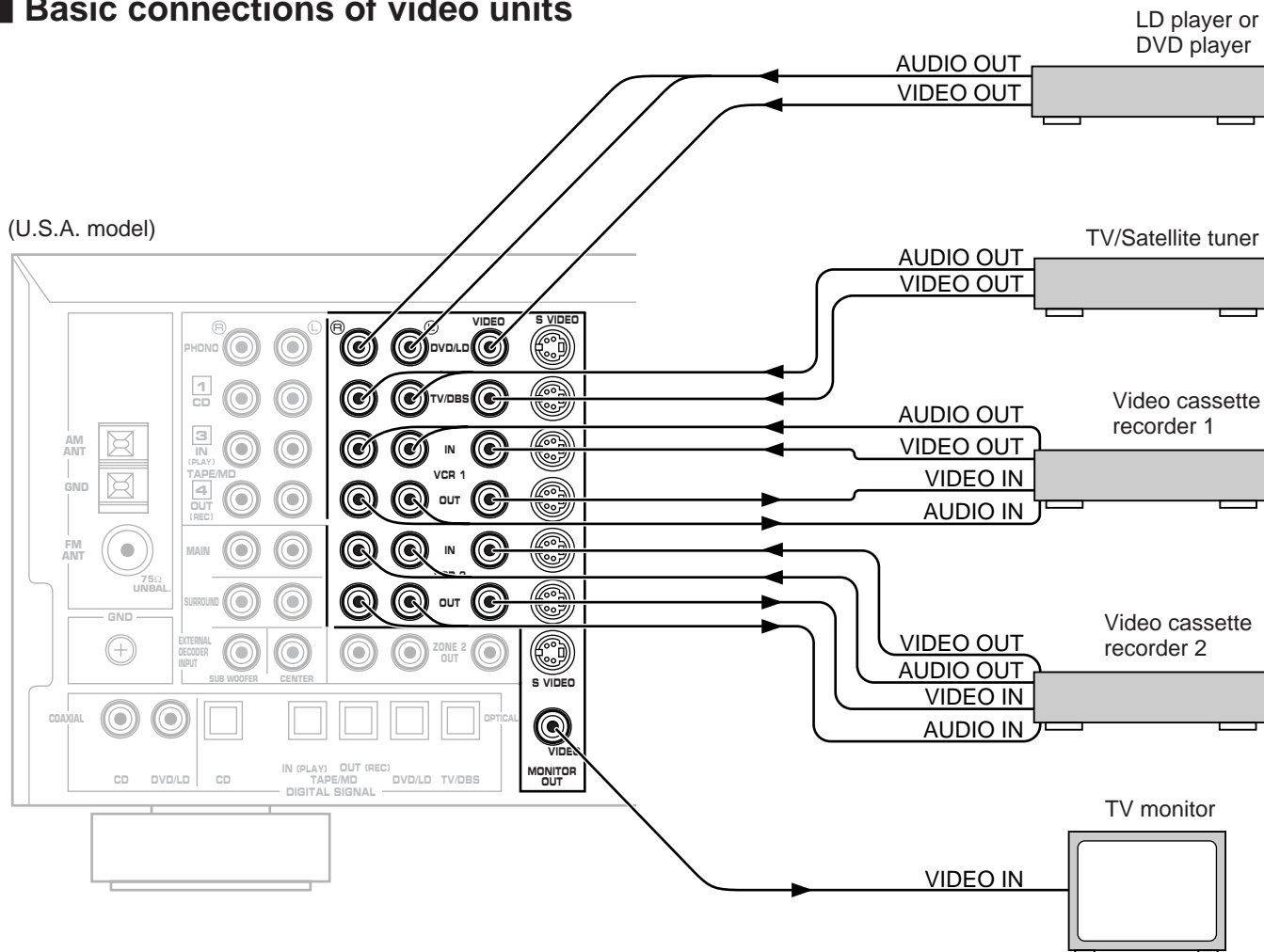

VIDEO AUX terminals (on the front panel)

These terminals are used to connect a video input source such as a camcorder.

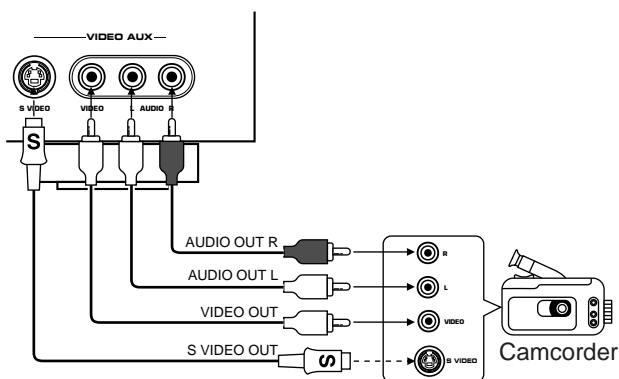

: S-video cable
(Refer to page 20 for details about the S VIDEO terminal.)

PAL/NTSC switch (China and General models only)

This unit is designed for use with the NTSC and PAL television formats. Set this switch to the position for the format your TV monitor employs.

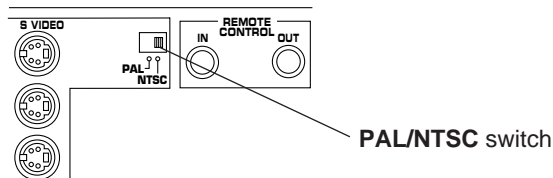

PAL: Set to this position if your TV monitor employs the PAL format.
Outputs signals in the PAL format no matter which format (PAL or NTSC) of video signal is sent from an external video unit to this unit.

NTSC: Set to this position if your TV monitor employs the NTSC format.
Outputs signals in the NTSC format no matter which format (PAL or NTSC) of video signal is sent from an external video unit to this unit.

Note
Be sure to input a video signal which employs the same format that your TV monitor employs, otherwise a picture will not be played back normally.

■ Connecting to digital (OPTICAL and COAXIAL) terminals

If your CD player, MD recorder, LD player, DVD player, TV/satellite tuner, etc. are equipped with coaxial or optical digital audio signal output terminals, they can be connected to this unit's COAXIAL or OPTICAL, or both terminals.

Digital audio signals are transmitted with less loss than analog audio signals. In addition, digital audio signal connections are necessary, especially for an LD player, a DVD player or a CD player to send signals encoded with Dolby Digital or DTS to this unit.

To make an optical digital connection between this unit and an external unit, remove the cover from each optical terminal, and then connect them by using a commercially available optical fiber cable that conforms to EIAJ standards. Other cables might not function correctly.

Even if you connect an audio/video unit to the OPTICAL (or COAXIAL) terminal of this unit, you must keep the unit connected with the same named analog audio signal terminals of this unit, because digital signal cannot be recorded by a tape deck or VCR connected to only analog audio signal terminals of this unit. You can switch the selection of input signals between "digital" and "analog" easily. (See page 38 for details.)

* However, if you connect an MD recorder or DAT to this unit's OPTICAL TAPE/MD IN and OUT terminals, it can record input sources connected to this unit's OPTICAL digital signal input terminals.

<U.S.A., Canada and Australia models>

(U.S.A. model)

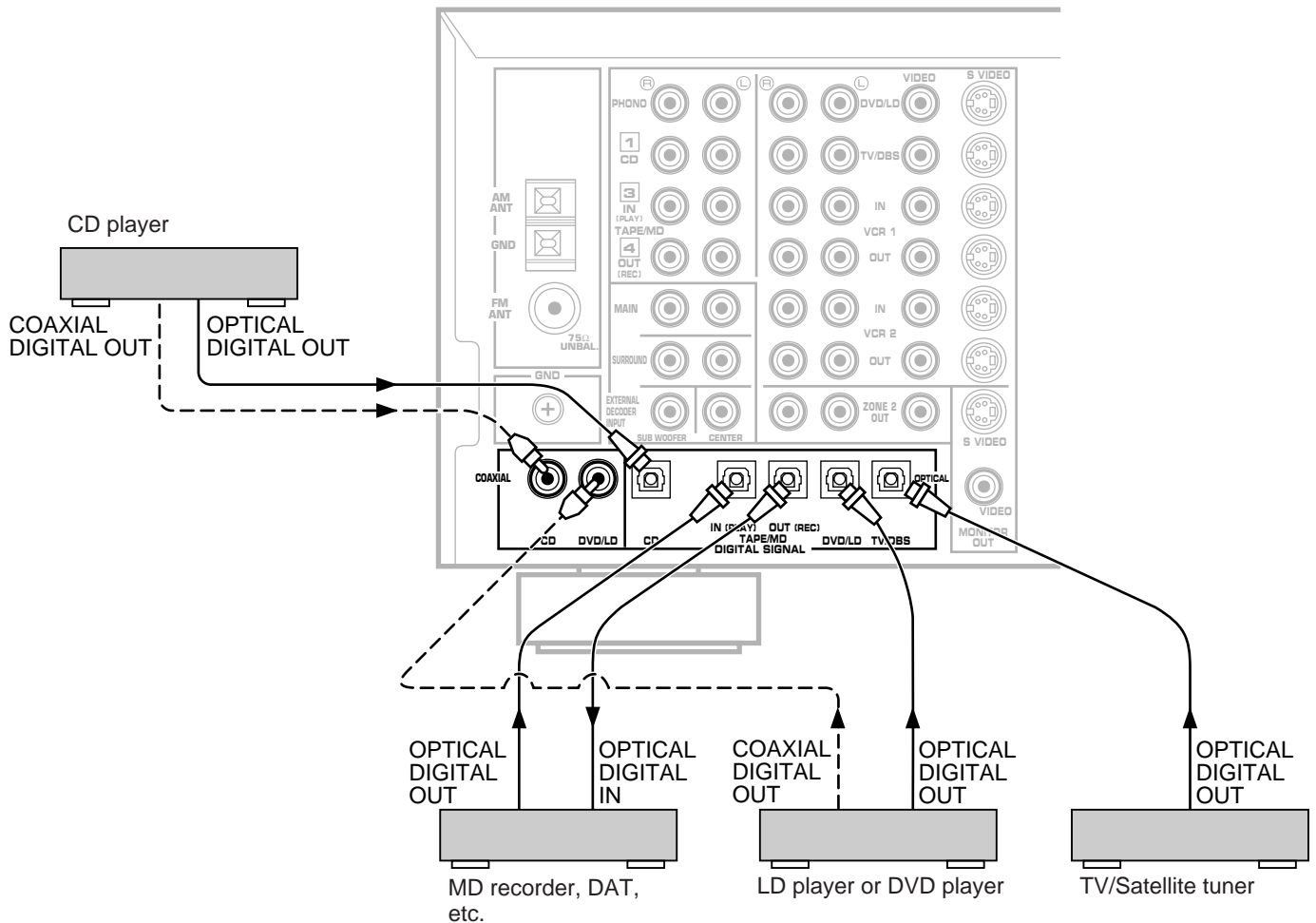

 : Optical fiber cable

 : Coaxial cable

Notes

- When you connect an audio/video unit to both of the digital and analog terminals of this unit, make sure to connect to both terminals of the same name.
- Be sure to attach the covers when the OPTICAL terminals are not being used, in order to protect the terminals from dust.
- In order to make this unit perform successful DTS-decoding, the DTS bitstream must not be altered, manipulated or corrupted in the process of sending the DTS bitstream from the DIGITAL OUT terminal of an external unit to a digital signal input terminal of this unit.
- Digital audio signals will not be output from the ZONE 2 OUT AUDIO SIGNAL terminals of this unit.
- All digital audio signal input terminals are applicable to the sampling frequency of 32 kHz, 44.1 kHz and 48 kHz.

<China, Singapore and General models>

(General model)

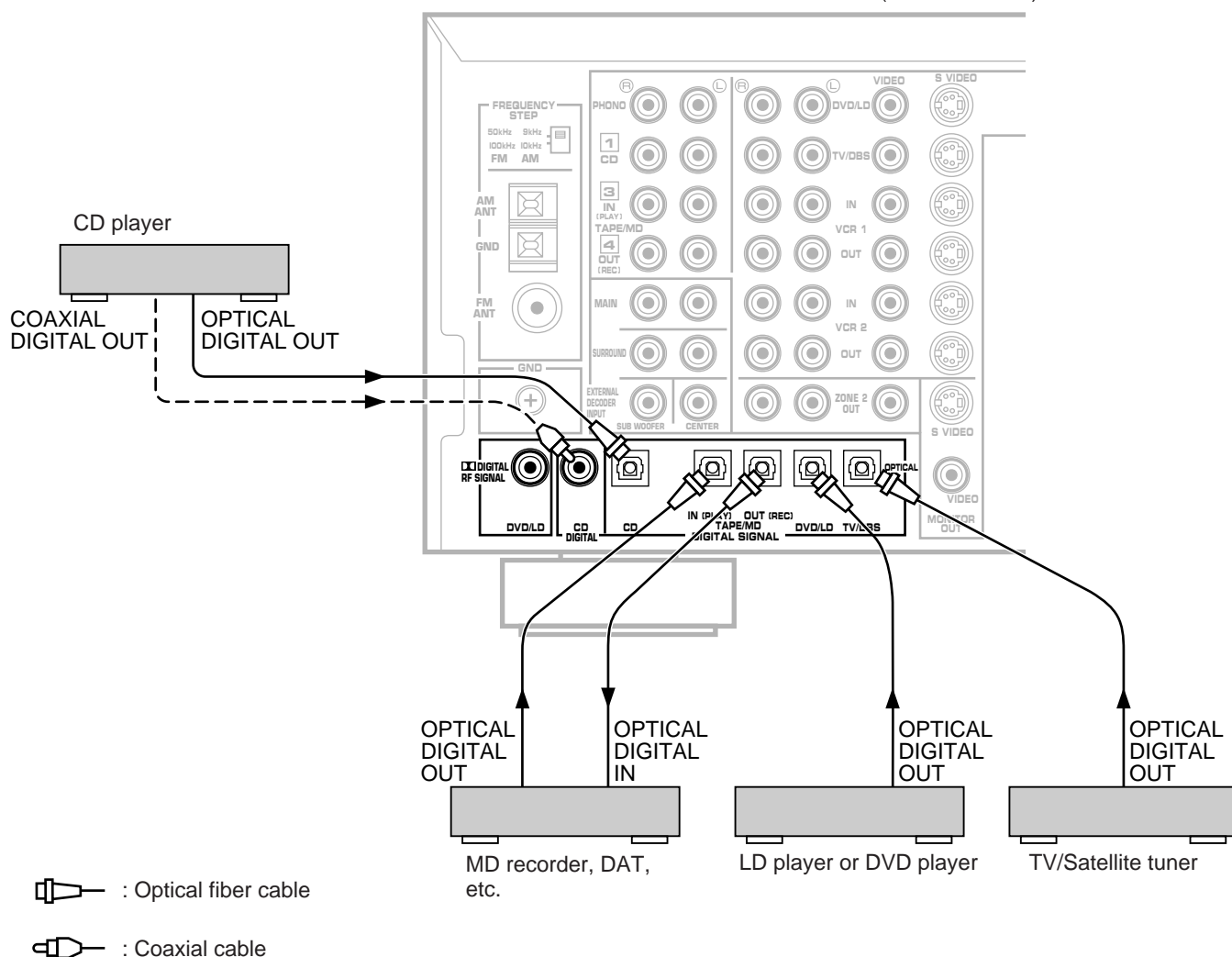

■ Connecting to DOLBY DIGITAL RF output of the DVD/LD/CD combi-player

<For U.S.A., Canada and Australia models>

If your DVD/LD/CD combi-player has a DOLBY DIGITAL RF signal output terminal, it can be connected to this unit by using an RF demodulator (separate purchase).

First, connect the DOLBY DIGITAL RF signal output terminal of the DVD/LD/CD combi-player to the DOLBY DIGITAL RF signal input terminal of the RF demodulator. Next, connect the coaxial digital signal output terminal of the RF demodulator to the COAXIAL digital signal input terminal of this unit.

This connection is necessary for sending audio signals of an LD source encoded with Dolby Digital to this unit.

It is also necessary to connect the DVD/LD/CD combi-player to this unit's analog audio signal input terminals regardless of the DOLBY DIGITAL RF signal connection. This is for playing back a source with Dolby Pro Logic Surround decoded or in normal stereo (or monaural).

You must also connect the optical digital signal output terminal of the DVD/LD/CD combi-player to the OPTICAL DVD/LD digital signal input terminal of this unit.

This connection is necessary for playing back a DVD source with Dolby Digital or DTS decoded, and playing back an LD source with DTS decoded.

When these connections are completed, set the input mode of the DVD/LD source to "AUTO", and you will hear sounds decoded with Dolby Digital even if signals are input to both COAXIAL and OPTICAL digital signal input terminals of this unit. This is because signals input to the COAXIAL terminal take priority over signals input to the OPTICAL terminal. Refer to page 38 for details about switching the input mode.

Notes

- If, for example, you play a CD on the DVD/LD/CD combi-player, there is no input to the COAXIAL terminal, so the signals input to the OPTICAL terminal take priority. In this case, switch off the RF demodulator to listen to CD sound without interference. However, if your RF demodulator is the Yamaha model APD-1, you do not have to switch it off.
- When you want to play an LD source encoded with Dolby Digital without decoding Dolby Digital, you must switch off the power of the RF demodulator.

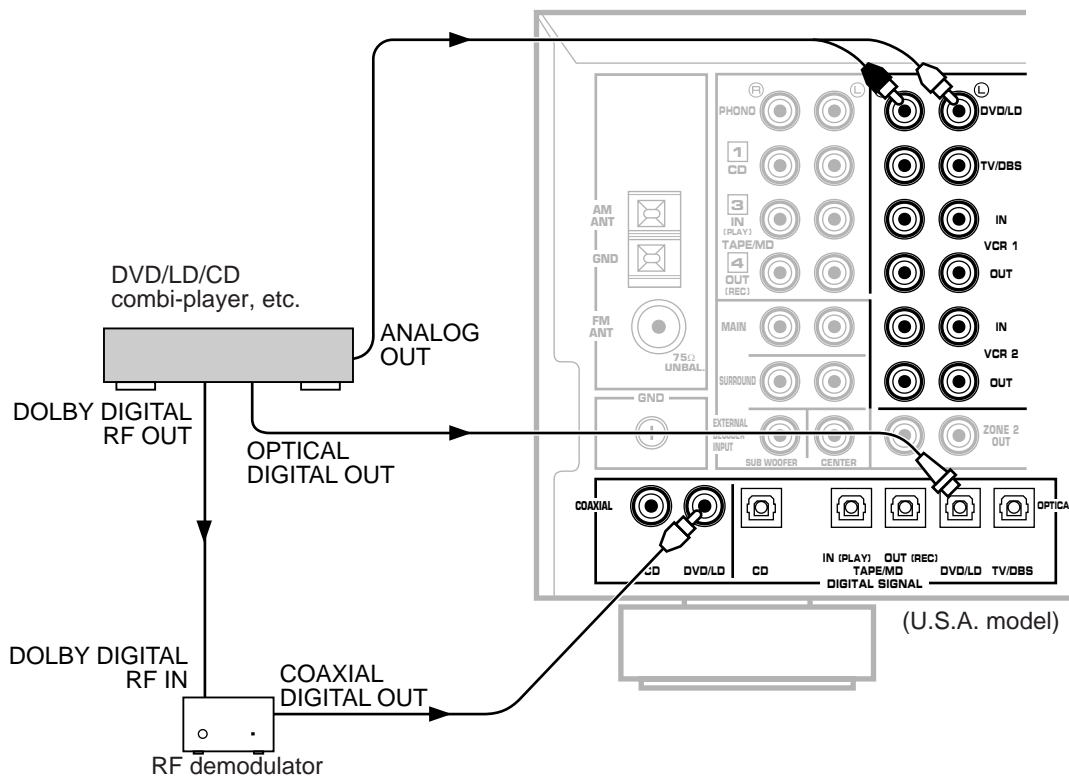

<For China, Singapore and General models>

If your DVD/LD/CD combi-player has a DOLBY DIGITAL RF signal output terminal, connect it to this unit's **DIGITAL RF SIGNAL** input terminal. Audio signals of an LD source encoded with the Dolby Digital are input to this unit by this connection.

* To play back an LD source with the Dolby Digital decoded, set the input mode of DVD/LD to "AUTO" or "D.D.RF". (Refer to page 38 for details.)

It is also necessary to connect the DVD/LD/CD combi-player to this unit's analog audio signal input terminals regardless of the DOLBY DIGITAL RF signal connection. This is for playing back a source with Dolby Pro Logic Surround decoded or in normal stereo (or monaural).

You must also connect the optical digital signal output terminal of the DVD/LD/CD combi-player to the OPTICAL DVD/LD digital signal input terminal of this unit.

This connection is necessary for playing back a DVD source with Dolby Digital or DTS decoded, and playing back an LD source with DTS decoded.

Note

DOLBY DIGITAL RF audio input signal cannot be recorded by a tape deck, MD recorder or VCR. To record a source played back on the DVD/LD/CD combi-player, it must be connected to the OPTICAL digital audio signal input terminal and analog audio input terminals of this unit.

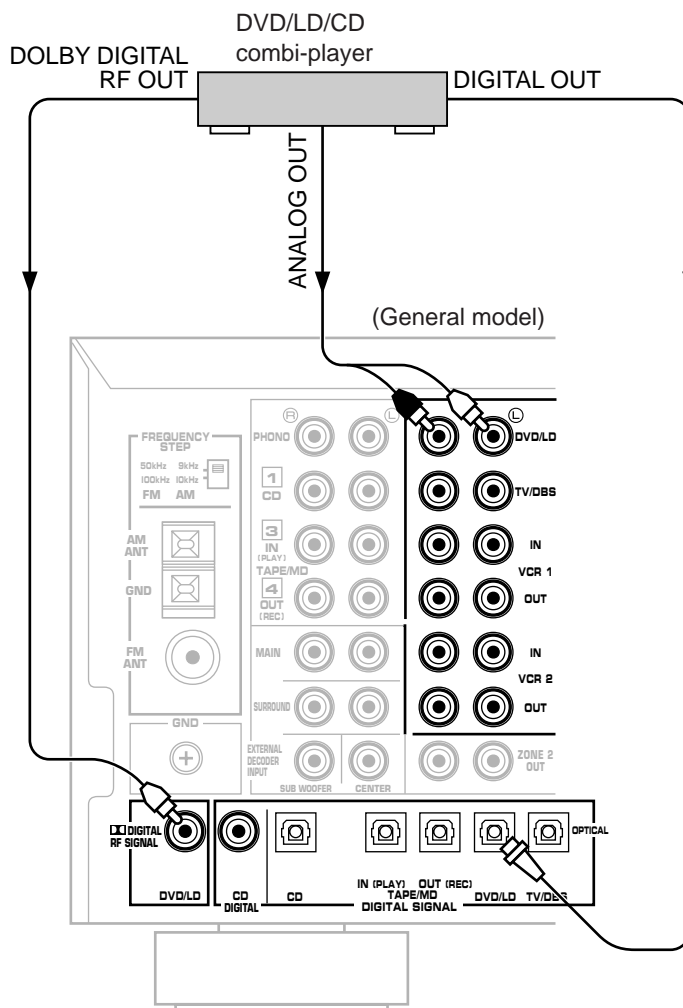

■ Connecting to S VIDEO terminals

If your video cassette recorder, LD player, etc. and your monitor are equipped with “S” video terminals, connect them to this unit’s S VIDEO terminals, and connect this unit’s S VIDEO MONITOR OUT terminal to the “S” video input of your monitor. With this connection, you can play back and record high quality pictures. Otherwise, connect the “composite” video terminals from your video cassette recorder, LD player, etc. to the VIDEO terminals of this unit, and connect this unit’s VIDEO MONITOR OUT terminal to the “composite” video input of your monitor.

Note

If video signals are sent to both S VIDEO input and VIDEO input terminals, the signals will be sent to their respective output terminals.

Notes about the Video superimpose

- If you watch a video source that is connected to both S VIDEO and VIDEO input terminals of this unit, signals of screen display information are output from only the S VIDEO MONITOR OUT terminal.
 - When no video signal is input to either S VIDEO or VIDEO input terminals of this unit, signals of screen display information are output from both S VIDEO MONITOR OUT and VIDEO MONITOR OUT terminals with a color background.
- * For China and General models, if the PAL/NTSC switch on the rear panel is set to “PAL”, nothing will be output from either S VIDEO MONITOR OUT or VIDEO MONITOR OUT terminal in this case.

S VIDEO terminals

This unit provides you with S VIDEO terminals in addition to standard type VIDEO terminals. S VIDEO terminals transmit video signals separated into luminance (Y) signals and color (C) signals. In comparison with S VIDEO terminals, standard type VIDEO terminals transmit “composite” video signals.

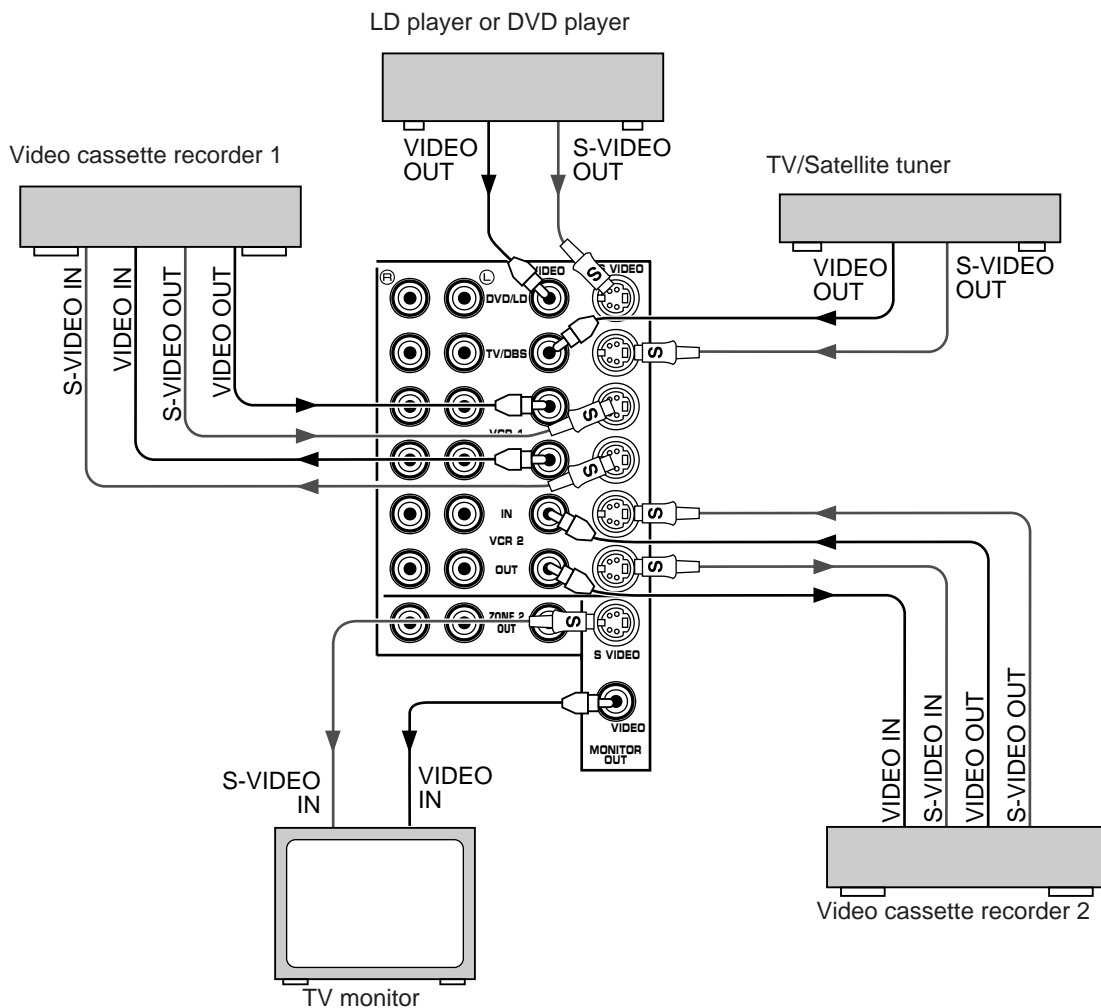

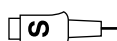
 : S-video cable

■ Connecting an external decoder of a future format to this unit

This unit is equipped with additional 6-channel audio signal input terminals (for left main, right main, center, left rear surround, right rear surround and subwoofer channels) for inputting signals from an external decoder of a future format to this unit.

To listen to a sound by reproducing signals input to these terminals, press the **EXT. DECODER** button on the front panel so that "EXT. DECODER" appears on the display. By doing so, the signals input to these terminals are sent to the corresponding SPEAKERS terminals and OUTPUT terminals of this unit.

Notes

- When signals input to these terminals are selected, the digital sound field processor cannot be used.
- The settings of "1. CENTER SPEAKER", "2. REAR SPEAKER", "3. MAIN SPEAKER" and "4. LFE/BASS OUT" in the SET MENU mode have no effect on the signals input to these terminals. The setting of "5. MAIN LEVEL" is effective. (Refer to pages 29 to 30 for details.)
- The adjustments of the output level of the center speaker, rear speakers and subwoofer are effective when the signals input to these terminals are selected as the input source. (Refer to pages 50 to 51 for details.)

(U.S.A. model)

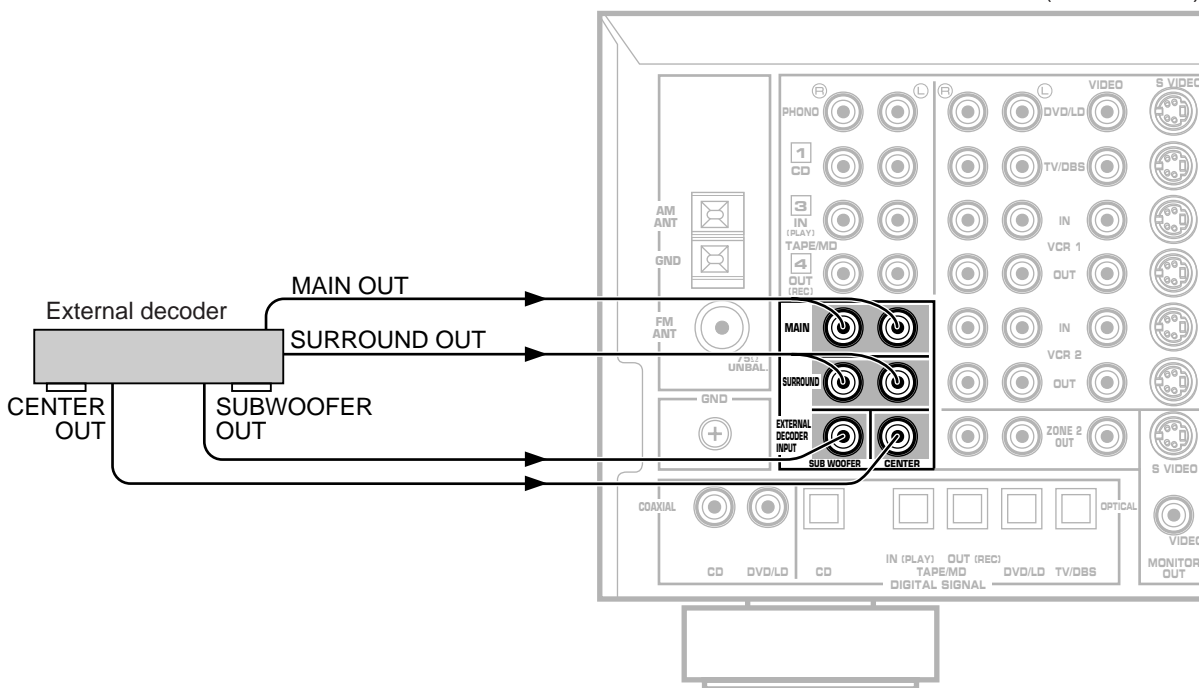

Speakers

Use speakers with the specified impedance shown on the rear of this unit.

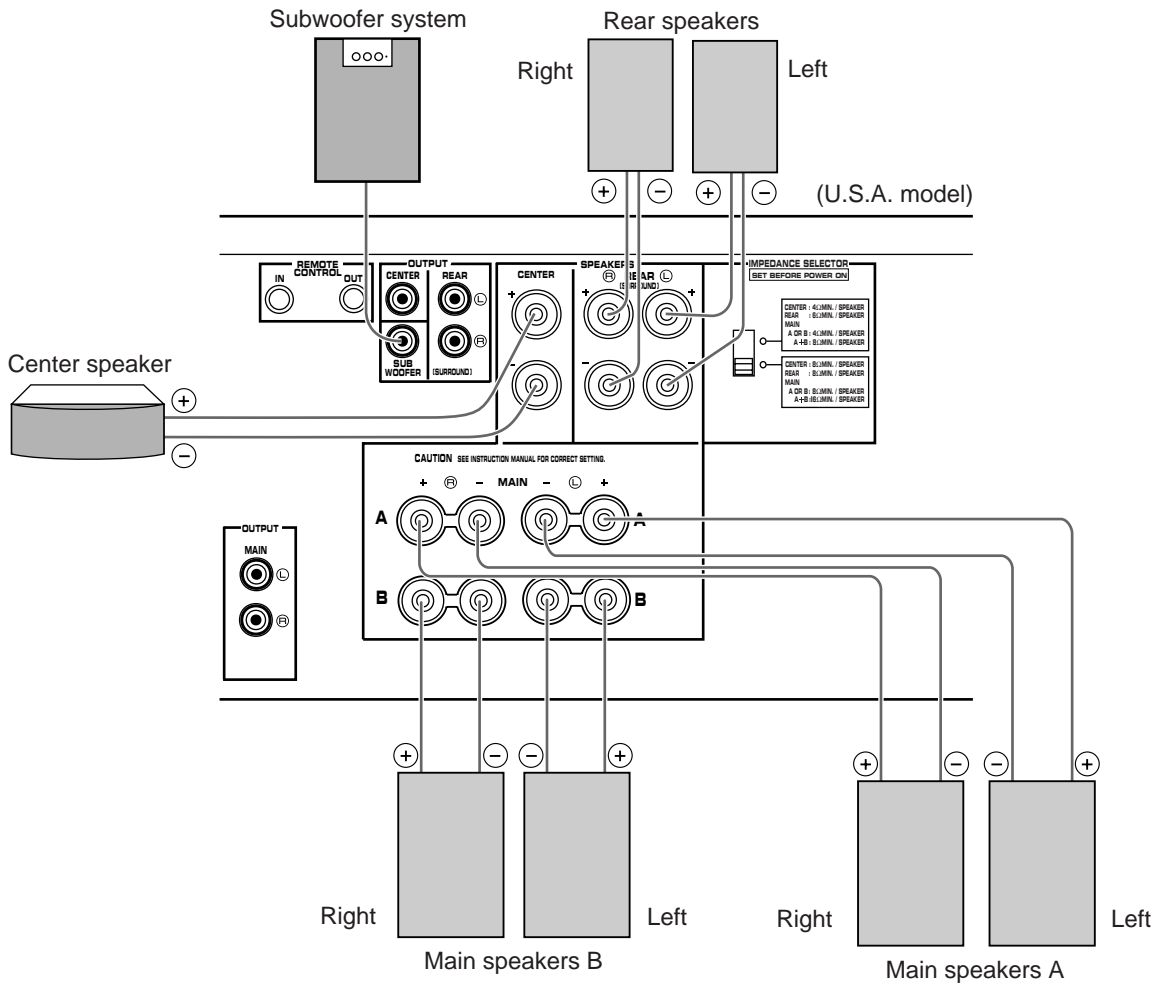

How to Connect:

Connect the **SPEAKERS** terminals to your speakers with the wire of the proper gauge (keep as short as possible). If the connections are faulty, no sound will be heard from the speakers. Make sure that the polarity of the speaker wires is correct. That is the + and - markings are observed. If these wires are reversed, the sound will be unnatural and lack bass.

Caution

Do not let the bare speaker wires touch each other or any metal part of this unit. This could damage this unit or the speakers, or both.

Red: positive (+)
Black: negative (-)

<Except Singapore model>

Banana Plug connections are also possible. Simply insert the Banana Plug connector into the corresponding terminal.

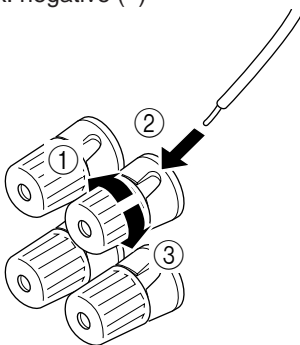

- ① Loosen the knob.
- ② Insert the bare wire.
[Remove approx. 5mm (1/4") insulation from the speaker wires.]
- ③ Tighten the knob and secure the wire.

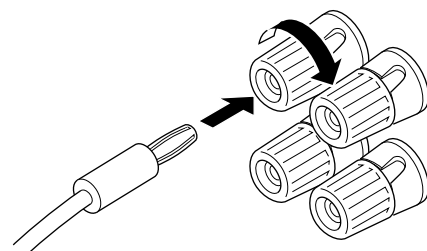

Note on main speaker connections:

One or two speaker systems can be connected to this unit. If you use only one speaker system, connect it to either the **SPEAKERS A** or **B** terminals.

Note on a subwoofer connection:

You may wish to add a subwoofer to reinforce low frequencies or to output low bass sound from the subwoofer channel when reproducing discrete signals.

When using a subwoofer, connect the SUBWOOFER terminal of this unit to the INPUT terminal of the subwoofer amplifier, and connect the speaker terminals of the subwoofer amplifier to the subwoofer.

With some subwoofers, including the Yamaha Active Servo Processing Subwoofer System, the amplifier and subwoofer are in the same unit. Such a subwoofer needs only the connection between the SUBWOOFER terminal of this unit and the INPUT terminal of the subwoofer.

(Refer to page 24 for details about the SUBWOOFER terminal.)

IMPEDANCE SELECTOR switch

WARNING

Do not change the **IMPEDANCE SELECTOR** switch setting while the power to this unit is on, otherwise this unit may be damaged.

IF THIS UNIT FAILS TO TURN ON WHEN THE STANDBY/ON SWITCH IS PRESSED:

The **IMPEDANCE SELECTOR** switch may not be set to either end. If so, set the switch to either end when this unit is in the standby mode.

IMPEDANCE SELECTOR

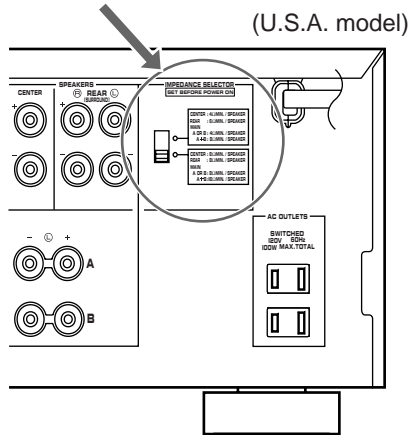

Select the position whose requirements your speaker system meets.

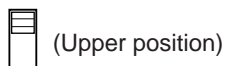

Center: <U.S.A. and Canada models>

The impedance of the speaker must be 4Ω or higher.

<Australia, China, Singapore and General models>

The impedance of the speaker must be 6Ω or higher.

Rear: The impedance of each speaker must be 6Ω or higher.

Main: If you use one pair of main speakers, the impedance of each speaker must be 4Ω or higher. If you use two pairs of main speakers, the impedance of each speaker must be 8Ω or higher.

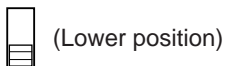

Center: The impedance of the speaker must be 8Ω or higher.

Rear: The impedance of each speaker must be 8Ω or higher.

Main: <Except Canada model>

If you use one pair of main speakers, the impedance of each speaker must be 8Ω or higher.

If you use two pairs of main speakers, the impedance of each speaker must be 16Ω or higher.

<For Canada model only>

The impedance of each speaker must be 8Ω or higher.

■ To drive main, center and/or rear speakers with external amplifiers

The speaker connections described on page 22 are fine for most applications. If for some reason, however, you wish to drive main, center and/or rear speakers with your existing amplifier, etc., the following terminals are available for connecting external amplifier(s) to this unit.

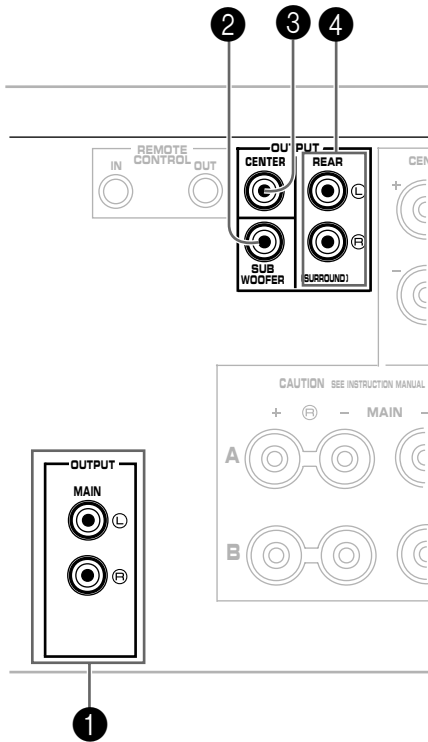

1 MAIN terminals

These terminals are for main channel line output. If you drive main speakers with an external stereo power amplifier, connect the input terminals of the external amplifier (MAIN IN or AUX terminals of an amplifier or a receiver) to these terminals.

There is no connection to these terminals when you use the built-in amplifier.

* Output signals from the MAIN terminals are affected by the use of **BASS**, **TREBLE**, **BALANCE** controls, **BASS EXTENSION** button and the **TONE BYPASS** button.

2 SUBWOOFER terminal

When using a subwoofer, connect its amplifier input to this terminal. Low frequencies distributed from the main, center and/or rear channels are output from this terminal. (The cut-off frequency of this terminal is 90 Hz.) Signals of LFE (low frequency effect) generated when Dolby Digital or DTS is decoded are also output if they are assigned to this terminal.

3 CENTER terminal

This terminal is for center channel line output. If you drive a center speaker with an external power amplifier, connect the input terminal of the external amplifier to this terminal.

There is no connection to this terminal when you use the built-in amplifier.

4 REAR (SURROUND) terminals

These terminals are for rear channel line output.

If you drive rear speakers with an external stereo power amplifier, connect the input terminals of the external amplifier (MAIN IN or AUX terminals of an amplifier or a receiver) to these terminals.

There is no connection to these terminals when you use the built-in amplifier.

Notes

- Output level of signals from all of these terminals are adjusted by the use of **VOLUME** control on the front panel or **MASTER VOLUME** keys on the remote controller.
- If an external power amplifier is connected to the MAIN, CENTER or REAR output terminals, do not use the corresponding **SPEAKERS** terminals (MAIN, CENTER or REAR).

Antennas

- Each antenna should be connected to the designated terminals correctly, as shown in the following figure.
- Both AM and FM indoor antennas are included with this unit. In general, these antennas will probably provide sufficient signal strength. Nevertheless, a properly installed outdoor antenna will give clearer reception than an indoor one. If you experience poor reception quality only with the indoor antennas, the use of an outdoor antenna may result in improvement.

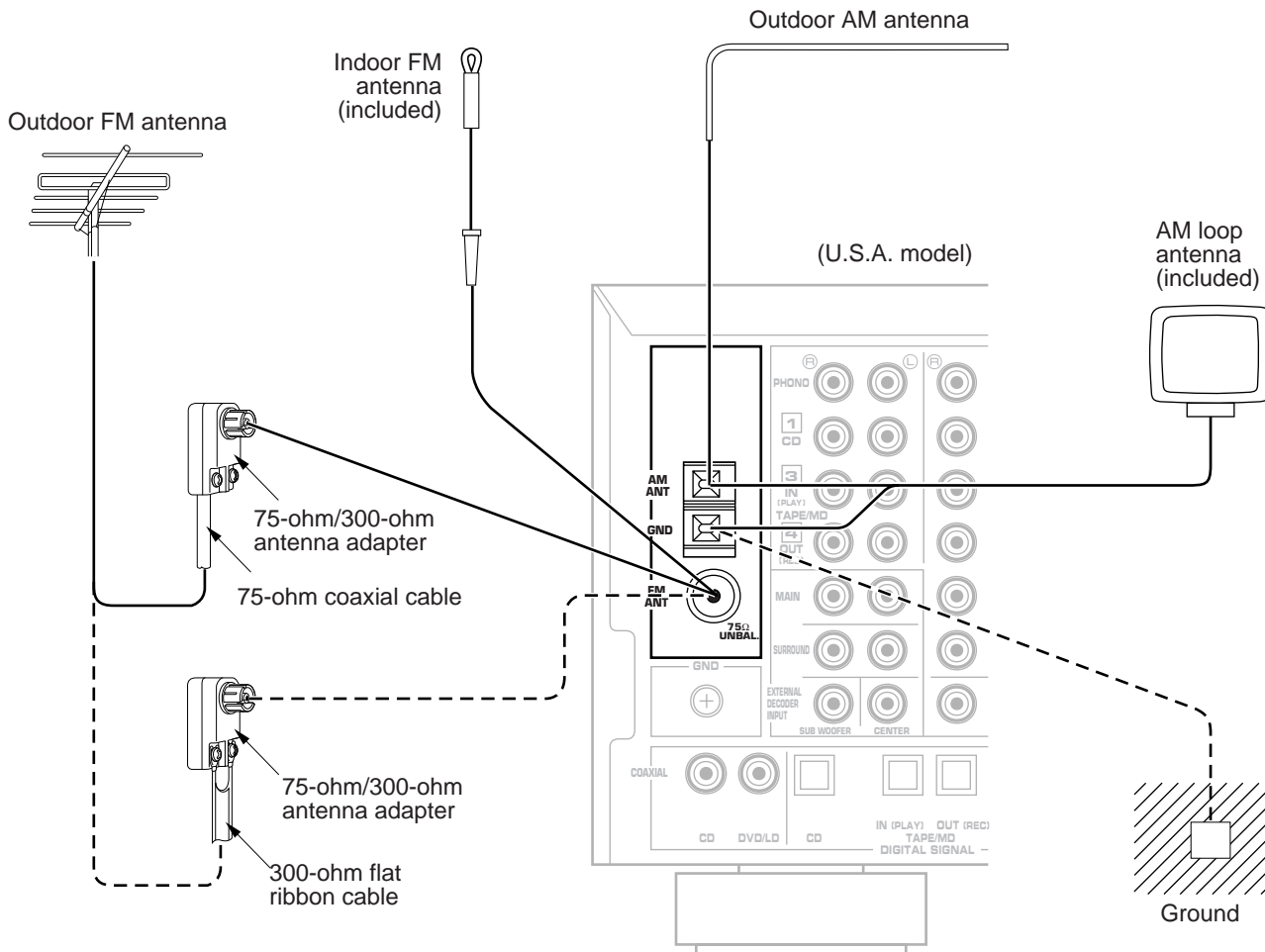

■ Connecting the AM loop antenna

1. Press the tab and unlock the terminal hole.
2. Connect the AM loop antenna lead wires to the AM ANT and GND terminals.
3. Return the tab back to the original position to lock the lead wires. Lightly pull on the lead wires to confirm a good connection.

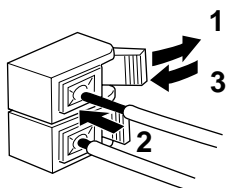

4. Attach the loop antenna to the antenna stand.

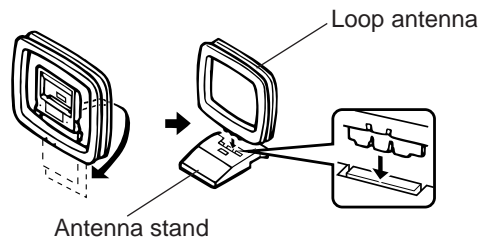

5. Orient the AM loop antenna so that the best reception is obtained.

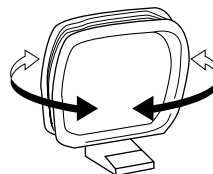

Notes

- The AM loop antenna should be placed apart from the main unit. The antenna may be hung on a wall.
- The AM loop antenna should be kept connected, even if an outdoor AM antenna is connected to this unit.

■ Connecting the indoor FM antenna

Connect the included indoor antenna to the 75Ω UNBAL. FM ANT terminal.

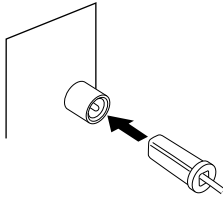

Note

Do not use an outdoor FM antenna and the indoor FM antenna at the same time.

GND terminal

For maximum safety and minimum interference, connect the **GND** terminal to a good ground. A good ground is a metal stake driven into moist earth.

■ Optional outdoor AM antenna

If this unit is placed in steel buildings or an area far from broadcasting stations, it may be necessary to install an outside long wire antenna.

■ Optional outdoor FM antenna

Consult your dealer or authorized service center about the best method of selecting and erecting an outdoor FM antenna.

The choice of the flat ribbon cable is also important. Flat ribbon cable performs well electrically, and is cheaper and somewhat easier to handle when routing it through windows and around rooms. Coaxial cable is more expensive, does a much better job of minimizing interference, is less prone to the effects of weather and close-by metal objects, and is nearly as good a signal conductor as flat ribbon cable. Coaxial cable is somewhat more difficult to install at the point where the cable enters the building. If coaxial cable is selected, make sure the antenna is designed to be used with this type of cable.

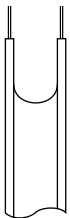

300-ohm flat ribbon cable

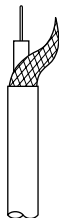

75-ohm coaxial cable

* Use a 75-ohm/300-ohm antenna adapter (not included) or a 75-ohm antenna adapter (not included) for connections.

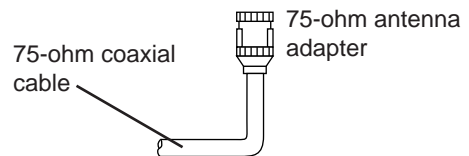
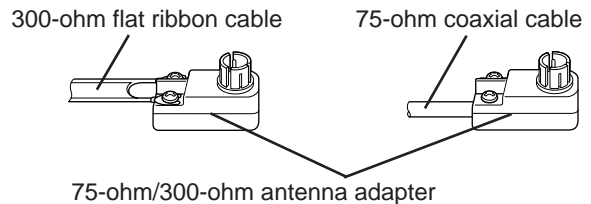

Notes for FM antenna installation

- To minimize the influence of automobile ignition noise, locate the antenna as far from heavy traffic as possible.
- Keep the flat ribbon cable or coaxial cable as short as possible. Do not bundle or roll up an excess of the cable.
- The antenna should be at least two meters (6.6 feet) from reinforced concrete walls or metal structures.

Plugging in this unit

- After completing all connections, plug the AC power cord into an AC outlet.
- Unplug the AC power cord from the AC outlet if this unit is not to be used for a long period of time.

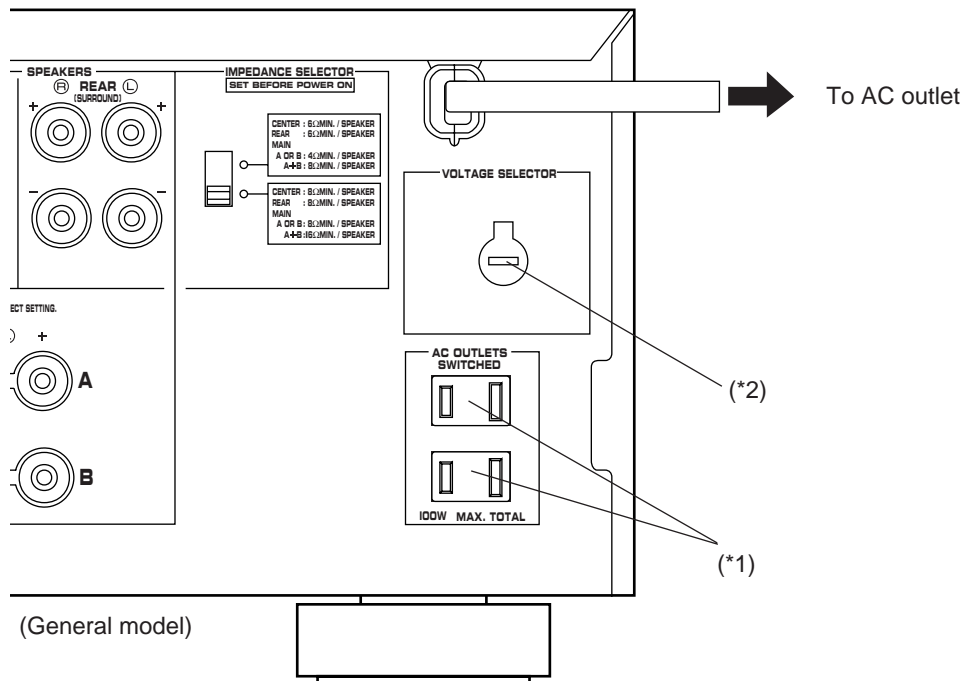

(*1):
AC OUTLET(S)
 (U.S.A., Canada, China, Singapore and General models) 2 SWITCHED OUTLETS
 (Australia model)..... 1 SWITCHED OUTLET

Use these to connect the power cords of your components to this unit.

The power to the **SWITCHED** outlets is controlled by this unit's **STANDBY/ON** switch or the remote controller's **SYSTEM POWER ON** and **STANDBY** keys. These outlets will supply power to any connected unit whenever this unit is turned on. The maximum power (total power consumption of components) that can be connected to the **SWITCHED AC OUTLET(S)** is 100W.

(*2):
Voltage Selector (China and General Models only)

The voltage selector on the rear panel of this unit must be set for your local main voltage **BEFORE** plugging into the AC main supply.
 Voltages are 110/120/220/240 V AC, 50/60 Hz.

On screen display

If you connect your VCR, LD player, video monitor, etc. to this unit, you can take advantage of this unit's capability to display program titles, parameter data and information for various setting changes and adjustments on your video monitor screen. This information will be superimposed over the video image.

If there is no video source connected or it is turned off, the information will be displayed over a blue colored background.

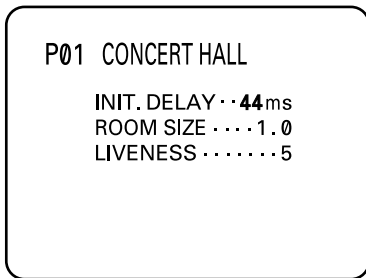

Note: The program titles, parameter data and other information are also displayed on the display panel of this unit.

Selecting a type of display

You can change the type of display showing various information on the monitor screen by pressing the **ON SCREEN** display key on the remote controller. Press this key to change the screen to a full or simple display, or no display at all.

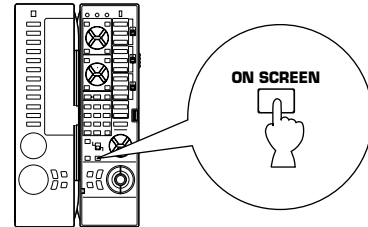

(Example)

Full display

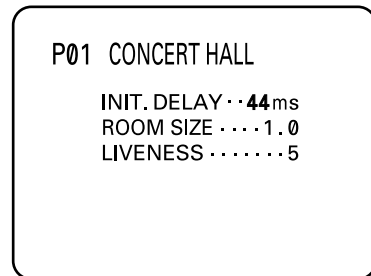

Simple display

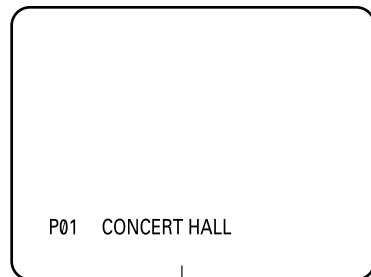

Goes off after being displayed for several seconds.

Notes

- When making a setting change or adjustment in the SET MENU mode, or adjusting the speaker balance by using the test tone, information is fully displayed on the monitor screen even if another type of display is currently selected.
- Information displayed on the monitor screen in this way cannot be recorded by a VCR.

Selecting the output modes (“SET MENU” mode)

The following functions control the output signals to the speakers in your audio system. When speaker connections are all completed, select a proper position on each function to maximize the performance of your speaker system.

* For details about the SET MENU mode, refer to pages 56 to 59.

1. CENTER SPEAKER
2. REAR SPEAKER
3. MAIN SPEAKER
4. LFE/BASS OUT
5. MAIN LEVEL

■ Function description

1. CENTER SPEAKER

Choices: **LARGE (LRG)/SMALL (SML)/NONE**

Preset position: **LRG**

- LRG:** When your center speaker is approximately the same size as the main speakers.
- SML:** When you use a center speaker that is smaller than the main speakers.
In this position, low bass signals (below 90 Hz) at the center channel are output from the SUBWOOFER terminals (or the main speakers if the MAIN position is selected on “4. LFE/BASS OUT”).
- NONE:** When you do not have a center speaker.
The center channel sound will be output from the left and right main speakers.

2. REAR SPEAKER

Choices: **LARGE/SMALL**

Preset position: **LARGE**

- LARGE:** If your rear speakers have a high ability for bass reproduction, or a subwoofer is connected to the rear speaker in parallel.
In this position, full range signals are output from the rear speakers.
- SMALL:** If your rear speakers do not have a high ability for bass reproduction.
In this position, low bass signals (below 90 Hz) at the rear channels are output from the SUBWOOFER terminals (or the main speakers if the MAIN position is selected on “4. LFE/BASS OUT”).

3. MAIN SPEAKER

Choices: LARGE/SMALL

Preset position: LARGE

LARGE: If your main speakers have a high ability for bass reproduction.

In this position, full range signals present at the main channels are output from the main speakers.

SMALL: If your main speakers do not have a high ability for bass reproduction. However, if your system does not include a subwoofer, do not select this position.

In this position, low bass signals (below 90 Hz) at the main channels are output from the SUBWOOFER terminals (if the SW or BOTH position is selected on "4. LFE/BASS OUT").

4. LFE/BASS OUT

Choices: SW/MAIN/BOTH

Preset position: SW

MAIN: If your system does not include a subwoofer. In this position, full range signals present at the main channels, signals from the LFE channel and other low bass signals that are selected on "1. CENTER SPEAKER" to "3. MAIN SPEAKER" to be distributed from other channels are output from the main speakers.

SW/BOTH:

Select either the SW or BOTH position if your system includes a subwoofer.

In either position, signals at LFE channel and other low bass signals that are selected on "1. CENTER SPEAKER" to "3. MAIN SPEAKER" to be distributed from other channels are output from the SUBWOOFER terminals.

When the LARGE position is selected on "3. MAIN SPEAKER", in the **SW** position, no signal is distributed from the main channels to the SUBWOOFER terminals, however in the **BOTH** position, low bass signals from the main channels are output to both of the main speakers and the SUBWOOFER terminals.

5. MAIN LEVEL

Choices: Normal/-10dB

Preset position: Normal

Normal: Normally, select this position.

-10dB: If the volume levels to the center and/or rear speakers are lower than the level to the main speakers even though they are adjusted to maximum. The volume level to the main speakers are decreased by 10 dB, so you can adjust the speaker output level balance properly.

Note

The settings of "1. CENTER SPEAKER", "2. REAR SPEAKER", "3. MAIN SPEAKER" and "4. LFE/BASS OUT" have no effect on the signals input to the EXTERNAL DECODER INPUT terminals on the rear of this unit.

■ Changing selections

Refer to the display panel or the monitor screen when changing the selections.

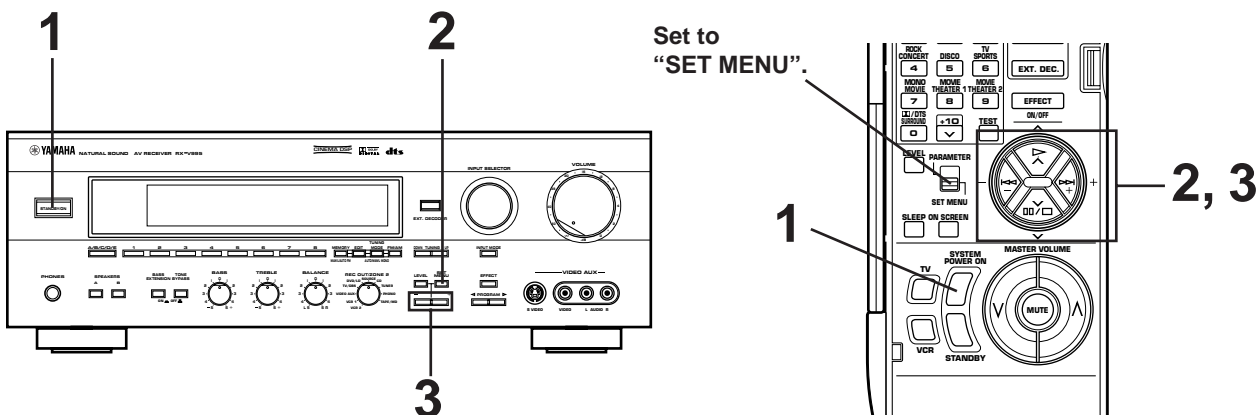

When using the remote controller, set the **PARAMETER/SET MENU** switch to the **SET MENU** position.
Note: The cover of the remote controller must be open.

Remote control

3 Use one of the buttons figured below to select the desired position.

Front panel

Remote control

or

↓

Changes.

1 Turn on the power of this unit. (If necessary, turn on the power of the monitor to display information.)

Front panel

Remote control

or

2 Select the function "1. CENTER SPEAKER" by using one of the following methods.

Front panel

Remote control

Press once or more.

or

Press once or more.

↓

4 Follow the same procedure for "2. REAR SPEAKER", "3. MAIN SPEAKER", "4. LFE/BASS OUT" and/or "5. MAIN LEVEL".
 First select the function by following step 2, and then select the proper position by following step 3.

Speaker balance adjustment

This procedure lets you adjust the sound output level balance between the main, center and rear speakers using the built-in test tone generator. After the adjustments, the sound output level heard at the listening position will be the same from each speaker. This is important for the best performance of the digital sound field processor, the Dolby Digital decoder, the Dolby Pro Logic Surround decoder and the DTS decoder.

The adjustment of each speaker output level should be done at your listening position with the remote controller.

Note: The cover of the remote controller must be open.

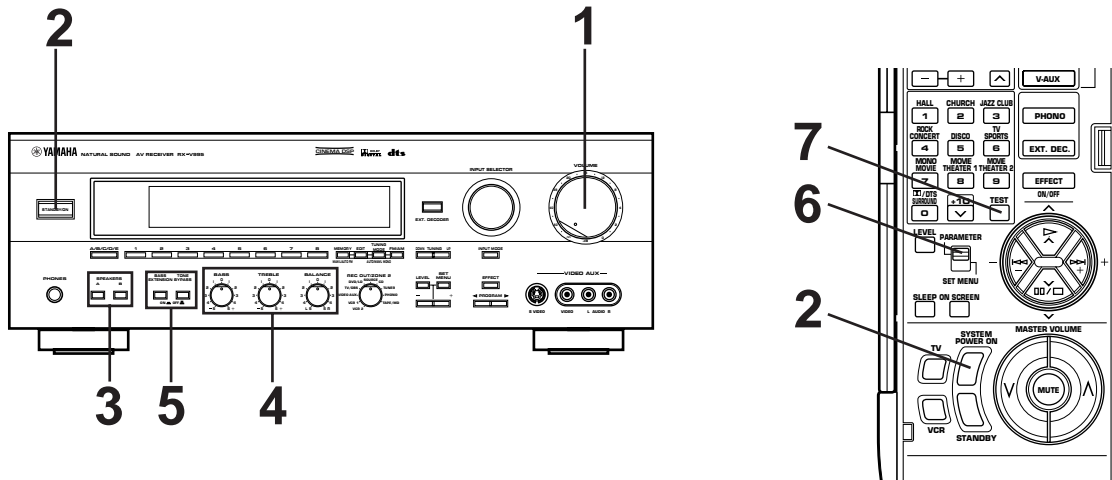

1 Front panel

Set to the "∞" position.

2 Turn on the power.

Front panel: or Remote control:

3 Select main speakers A or B. The corresponding indicator will be illuminated.

Front panel

SPEAKERS

A B

* Both speakers A and B can be selected.

4 Front panel

BASS **TREBLE** **BALANCE**

Set to the "0" position.

5 Front panel

BASS TONE
EXTENSION BYPASS

Set to the "OFF (⬇️)".

6 Set the **PARAMETER/SET MENU** switch on the remote controller to the **PARAMETER** position.

Remote control

PARAMETER
SET MENU

7 Press the **TEST** key on the remote controller to enter the test mode.

Remote control

TEST → **TEST LEFT**

CONTINUED

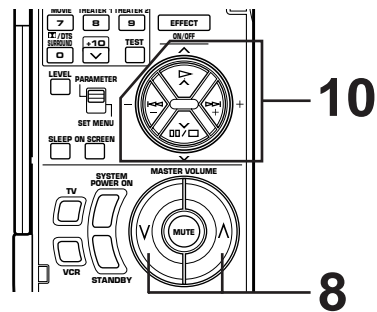
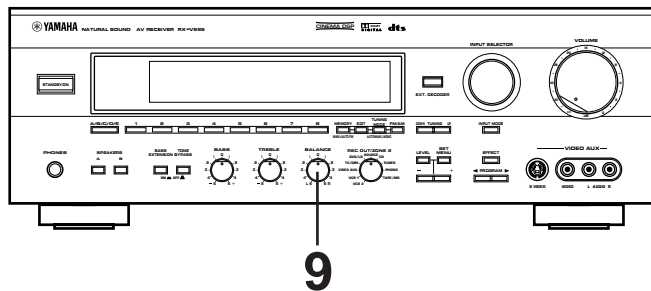

8 Turn up the volume.

Remote control

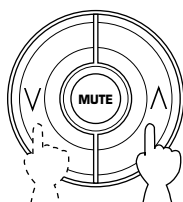

You will hear a test tone (like pink noise) from the left main speaker, then the center speaker, then the right main speaker, then the right rear speaker, and then the left rear speaker, for about 2.5 seconds each. The display changes as shown below.

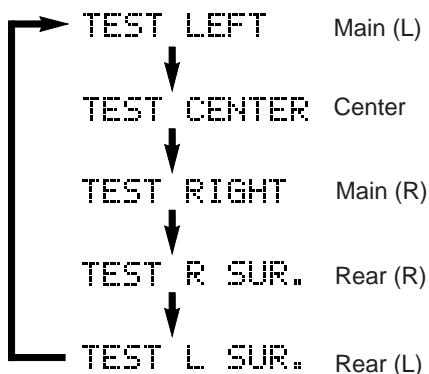

* The state of the test tone output is also shown on the monitor screen by an image of the audio listening room. This is convenient for adjusting each speaker level.

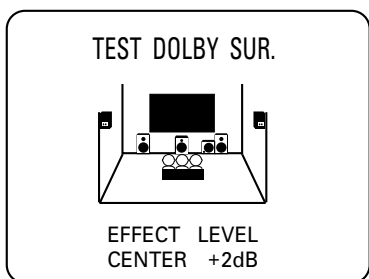

* If the function "1. CENTER SPEAKER" in the SET MENU mode is set in the "NONE" position, you will hear the center channel test tone from the left and right main speakers.

9 Adjust the **BALANCE** control so that the effect sound output level of the left main speaker and the right main speaker are the same.

Front panel



10 Adjust the sound output levels of the center speaker and the rear speakers so that they become almost the same as the main speakers.

How to adjust:

Pressing the + or – key adjusts the level to the speaker (except the main speakers) currently outputting the test tone.

- * Pressing the + key raises and the – key lowers the level.
- * While adjusting, the test tone is fixed on the selected speaker.

Remote control

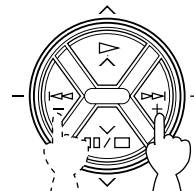

If desired, you can select a speaker to output the test tone by pressing the ^ or v key once or more so that "CENTER", "R SUR." or "L SUR." appears on the display.

- * While holding the ^ or v key pressed, the test tone is fixed on the selected speaker.
- * "CENTER" shows the center speaker is selected, "R SUR." shows the right rear speaker, and "L SUR." shows the left rear speaker.
- * The output level of the selected speaker can be adjusted by the + or – key.

Remote control

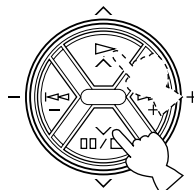

CONTINUED

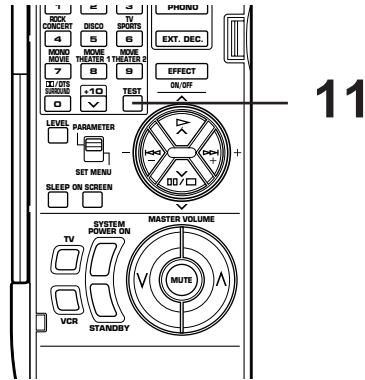

11 When the adjustment is finished, press the **TEST** key once again to cancel the test tone.

Remote control

Notes

- Once you have completed these adjustments, you can adjust the sound level on your audio system by using the **VOLUME** control (or the **MASTER VOLUME** keys on the remote controller) only.
- If you use external power amplifiers, you may also use their volume controls to obtain proper balance.
- If the function “1. CENTER SPEAKER” in the SET MENU mode is set in the “NONE” position, in step 10, the sound output level of the center speaker cannot be adjusted. This is because in this mode, the center sound is automatically output from the left and right main speakers.
- If there is insufficient sound output from the center and rear speakers, you may decrease the main speaker output level by setting the function “5. MAIN LEVEL” in the SET MENU mode in the “-10dB” position.

BASIC OPERATION

Playing a source

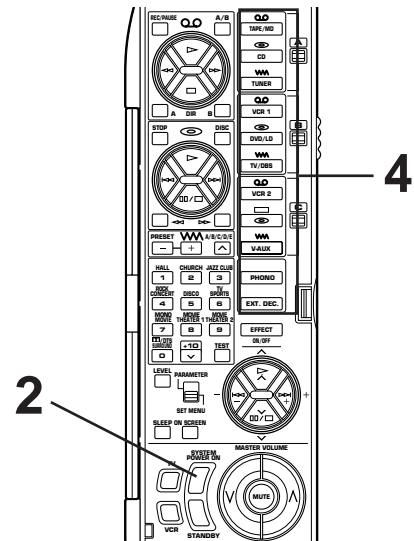
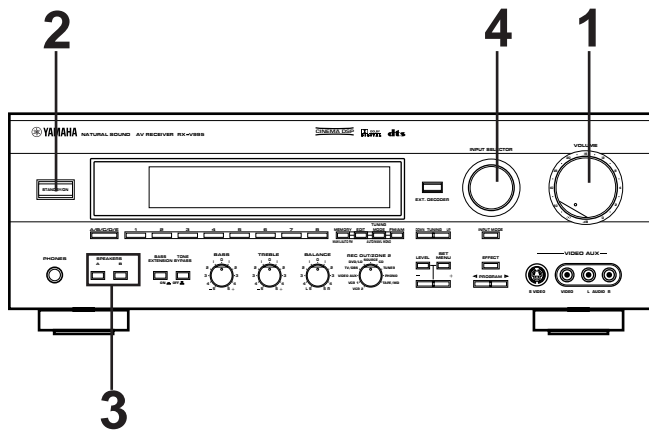

1 Front panel

Set to the "∞" position.

2 Turn on the power.

Front panel

Remote control

3 Select main speakers A or B. The corresponding indicator will be illuminated.

Front panel

* Both speakers A and B can be selected.

4 Select an input source.
(For video sources, turn on the TV/monitor.)
The selected source is shown on the display panel and the monitor screen.

Front panel

Remote control

or

↓

DVD/LD AUTO		DVD/LD ◀	CD
		TV/DBS	TUNER
		V-AUX	PHONO
		VCR 1	TAPE/MD
		VCR 2	

Name of the selected input source

To select the source connected to the EXTERNAL DECODER INPUT terminals, press the **EXT. DECODER** button. "EXT. DECODER" will be illuminated on the display. (Refer to page 37 for details.)

CONTINUED

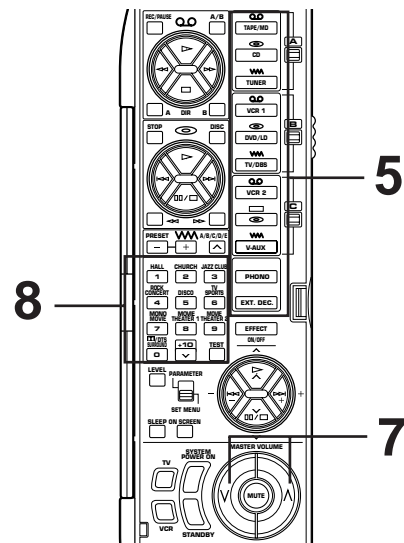
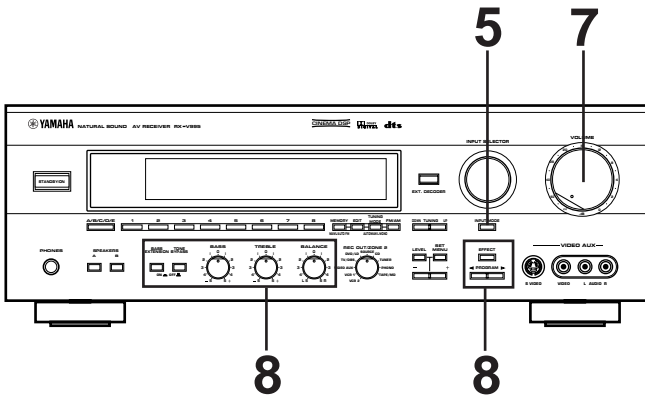

5 The current input mode is also shown for a source that inputs two or more types of signals to this unit.

To change the input mode, press the **INPUT MODE** button on the front panel or the input selector key for the currently selected source on the remote controller. (Refer to page 38 for details on switching the input mode.)

Front panel

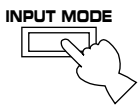

or

Remote control

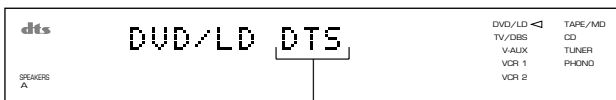

Input mode

6 Play the source. (Refer to page 43 for details on tuning.)

7

Front panel

Remote control

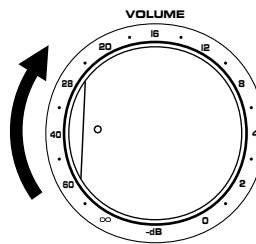

or

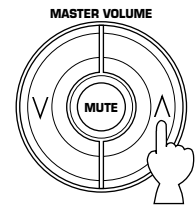

Adjust the output level.

8 Adjust the **BASS, TREBLE, BALANCE** controls, etc. (Refer to page 42) and use the digital sound field processor. (Refer to pages 47–49.)

When you finish using this unit

Press the **STANDBY/ON** switch on the front panel or the **STANDBY** key on the remote controller to enter the standby mode.

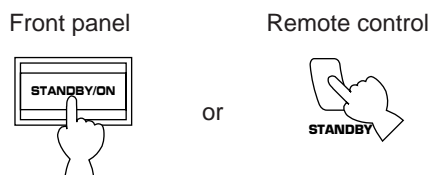

To select the source connected to this unit's EXTERNAL DECODER INPUT terminals as the input source.

Press the **EXT. DECODER** button. "EXT. DECODER" will appear on the display.

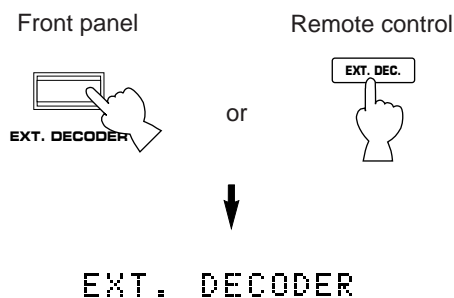

Note

The input source selected in this way has priority over any other input source already selected.

To select another input source, press the **EXT. DECODER** button again so that "EXT. DECODER" goes off from the display, and then use the **INPUT SELECTOR**.

Notes on input source selection

- Note that selecting an input source means that the source which is connected to the corresponding input terminals on the rear panel is selected.
 - * To select the source connected to the **VIDEO AUX** terminals on the front panel, select "**V-AUX**".
- The setting of the **EXT. DECODER** button cannot be canceled by selecting another input source. To cancel it, press the **EXT. DECODER** button again so that "EXT. DECODER" goes off from the display.
- If you select a video input source without canceling the setting of the **EXT. DECODER** button, you will see the picture of the video input source and hear the sound of the source selected by the **EXT. DECODER** button.
- If a different audio source is selected with the input selector keys on the remote controller while enjoying a video source, the sound from the newly selected audio source is heard, but the picture from the video source can still be seen.
- When you select an input source, the DSP program (or the state of no DSP program is used) which was used when the same input source was last selected will be automatically recalled.
- If a nonstandardized source is played back, or the unit playing back a source is not operating correctly, "INPUT DATA ERR" appears on the display.

■ Switching the input mode

This unit allows you to switch the input mode for sources that send two or more types of signals to this unit.

<U.S.A., Canada and Australia models>

The following three input modes are provided.

AUTO:

This mode is automatically selected when you turn on the power of this unit.

In this mode, input signal is automatically selected by the following order of priority.

1. Digital signal encoded with Dolby Digital or DTS, or normal digital input signals (PCM)
2. Analog input signal (ANALOG)

* For CD and DVD/LD sources, if digital signals are input from both of the OPTICAL and COAXIAL terminals, the digital signal from the COAXIAL terminal is selected.

DTS:

In this mode, only digital input signals encoded with DTS is selected even though other signals are input at the same time.

ANALOG

In this mode, only analog input signals are selected even though digital signals are input at the same time.

Select this mode when you want to use analog input signals instead of digital input signals.

<China, Singapore and General models>

● For CD, TAPE/MD and TV/DBS sources:

The following three input modes are provided.

AUTO:

This mode is automatically selected when you turn on the power of this unit.

In this mode, input signal is automatically selected by the following order of priority.

1. Digital signal encoded with Dolby Digital or DTS, or normal digital input signals (PCM)
2. Analog input signal (ANALOG)

* For a CD source, if digital signals are input from both of the OPTICAL and COAXIAL terminals, the digital signal from the COAXIAL terminal is selected.

DTS:

In this mode, only digital input signals encoded with DTS is selected even though other signals are input at the same time.

ANALOG

In this mode, only analog input signals are selected even though digital signals are input at the same time.

Select this mode when you want to use analog input signals instead of digital input signals.

● For DVD/LD source:

The following five input modes are provided.

AUTO:

This mode is automatically selected when you turn on the power to this unit.

In this mode, the input signal is automatically selected by the following order of priority.

1. Dolby Digital RF signal (DOLBY DIGITAL)
2. Digital signal encoded with Dolby Digital or DTS, or normal digital input signals (PCM)
3. Analog input signal (ANALOG)

D.D.RF:

In this mode, only Dolby Digital RF signal is selected.

DTS:

In this mode, only digital input signals encoded with DTS are selected even though other signals are input at the same time.

DGTL:

In this mode, only digital input signals (DOLBY DIGITAL, DTS or PCM) are selected even though other types of signals are input at the same time.

ANALOG

In this mode, only analog input signals are selected even though other types of signals are input at the same time.

Notes on input mode selection

- The input mode for a TV/DBS source is selected with function "12. TV/DBS INPUT" in the SET MENU mode. This unit will be automatically set to the selected input mode when the power is turned on.
- Set the input mode to the following mode to play a DVD/LD source encoded with Dolby Digital.
 - U.S.A., Canada and Australia models: AUTO
 - China, Singapore and General models: AUTO or D.D.RF
- Select the ANALOG mode to play a normal 2-channel source with a Dolby Pro Logic Surround program.
- The sound output may be interrupted in some LD and DVD players in the following situation:

The input mode is set to AUTO. A search is made while playing the disc encoded with Dolby Digital or DTS, then disc playing is restored. The sound output is interrupted for a moment because the digital input signal was selected again.
- The input mode cannot be changed for PHONO, TUNER, VCR 1, VCR 2 and VIDEO AUX sources because only analog signals are used.
- The present input mode appears on the front display and monitor screen when the input source is changed to DVD/LD, CD, TAPE/MD or TV/DBS, or the input mode is changed.

The present input signal is also shown on the monitor screen when the input mode is changed to AUTO, as shown below.

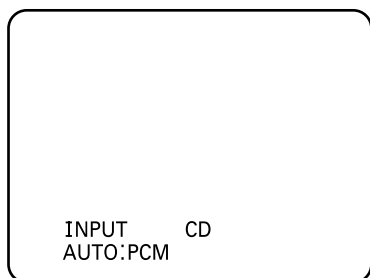

- * However, the present input signal will not be shown when the input mode is switched during the speaker test mode. Only AUTO will be displayed.

Notes on playing a source encoded with DTS

- Select the DTS mode when playing an LD or CD source encoded with DTS. (Red "dts" indicator is illuminated on the display panel.) If the "AUTO" mode is selected, a noise may be heard just after playback begins. Do not play these sources in the ANALOG mode because only background noise will be output from the speakers.
- This unit is automatically locked in the DTS decoding mode when playing a CD or LD source encoded with DTS in the AUTO mode to prevent background noise in future operation. The red "dts" indicator will be flashing. In this mode, no sound will be heard if a disc with normal digital signals (PCM) is played from a CD or LD source. To play back the disc normally, press the **INPUT MODE** button on the front panel, or, the input selector key for the current source on the remote controller.

Recording a source to tape (or MD) or dubbing from tape (or MD) to tape (or MD)

■ Recording the playing source to tape (or MD)

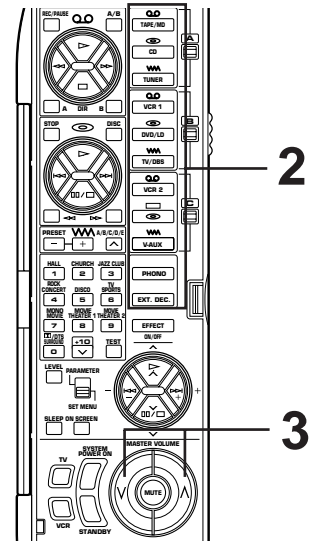
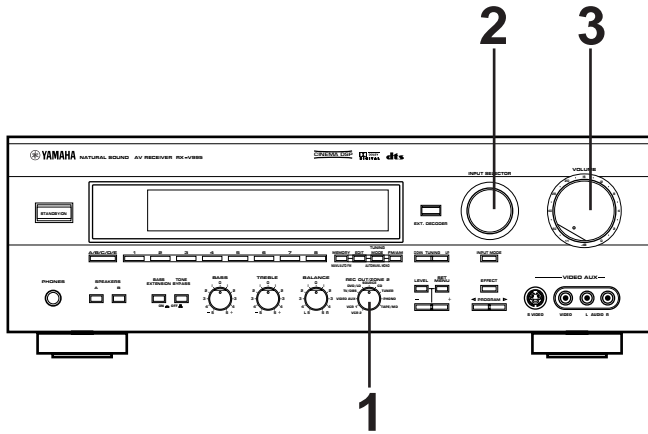

Note: The cover must be open when using the remote controller.

- 1 Set the **REC OUT/ZONE 2** selector to the **SOURCE** position.

Front panel

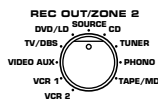

- 2 Select the source you want to record.
Front panel

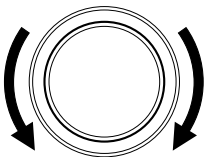

Remote control

or

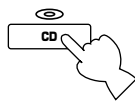

- 3 Play the source and then turn the **VOLUME** control up to confirm the input source. (Refer to page 43 for details on tuning.)

Front panel

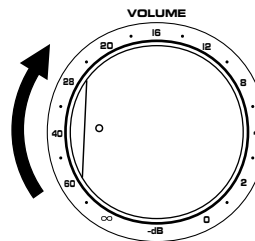

Remote control

or

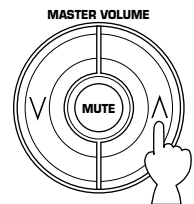

- 4 Begin recording to the tape deck (or MD recorder etc.) or VCR connected to this unit.

■ Recording a source to tape (or MD) while listening to (or watching) another source

The source (except for "SOURCE") that is selected with the **REC OUT/ZONE 2** selector can be recorded to a tape deck (MD recorder) and/or VCR, regardless of the **INPUT SELECTOR** setting.

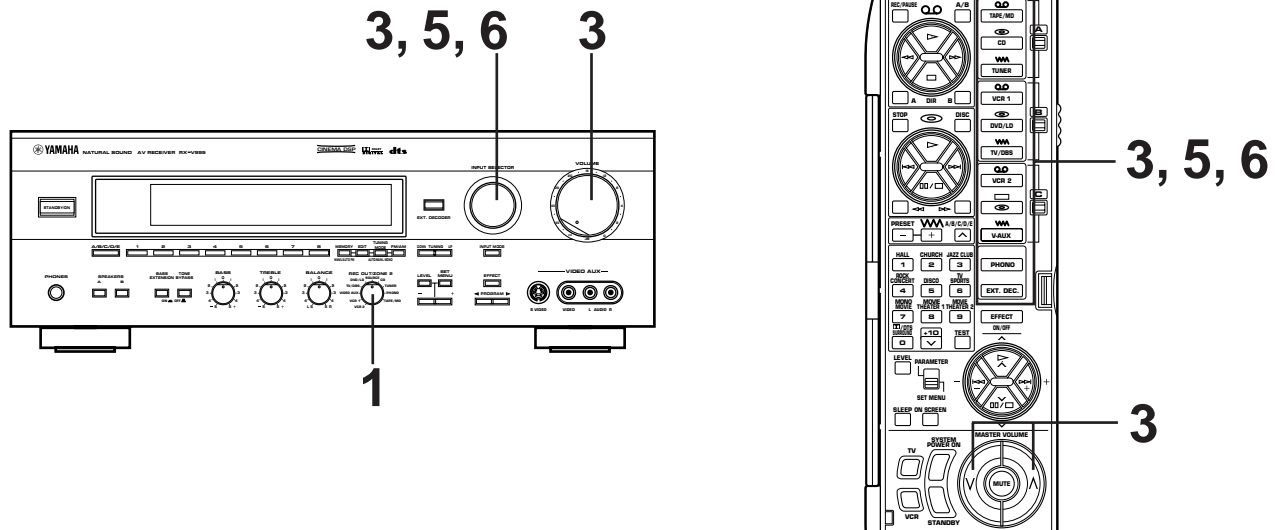

Note: The cover must be open when using the remote controller.

1 Select the source you want to record.

2 Play the source.

3 Select the source with the **INPUT SELECTOR** and adjust the **VOLUME** control to check the sound output.

Front panel Remote control

or

or

4 Begin recording on the tape deck (or MD recorder etc.) or VCR.

5 The sound and/or picture of the recording can be monitored by selecting the tape deck (or VCR) with the **INPUT SELECTOR**.

Front panel Remote control

or

6 Selecting another source to enjoy with the **INPUT SELECTOR** will not effect the recording.

Notes on recording

- The **VOLUME, BASS, TREBLE, BALANCE** controls, the **BASS EXTENSION** button and the settings of DSP have no effect on the material being recorded.
- Composite video and S video signals pass independently through this unit's video circuits. Therefore, when recording or dubbing video signals, if your video source unit is connected to provide only a S video (or only a composite video) signal, you can record only a S video (or only a composite video) signal on your VCR.
- A source that is connected to this unit between optical digital terminals only cannot be recorded by a tape deck or VCR other than the tape deck (or MD recorder etc.) connected to the OPTICAL TAPE/MD OUT terminal of this unit.

- A source of signals input to the EXTERNAL DECODER INPUT terminals of this unit cannot be recorded.
- Please check the copyright laws in your country to record from records, compact discs, radio, etc. Recording of copyright material may infringe on copyright laws.
- **<For China, Singapore and General models only>**
Dolby Digital RF audio input signal cannot be recorded by a tape deck or VCR. To record an LD source, the LD player must be connected to the OPTICAL digital audio signal input terminal and/or analog audio signal input terminals of this unit.

If you play back a video source that uses scramble or encoded signals to prevent it from being dubbed, there may be a case that display information superimposed on the picture and/or the picture itself is disturbed due to those signals.

Sound control

■ Adjusting the BALANCE control

Adjust the balance of the output volume to the left and right speakers to compensate for sound imbalance caused by speaker location or listening room conditions.



Note
This control is effective only for the sound from the main speakers.

■ Using the BASS EXTENSION button

Press this button inward (ON) to boost the bass frequency response at the main left and right channels while maintaining overall tonal balance. This function is effective for reinforcing the bass frequencies when a subwoofer is not used.

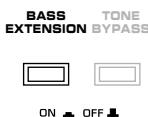

■ Adjusting the BASS and TREBLE controls

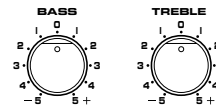

- BASS** : Turn this knob clockwise to increase (or counter-clockwise to decrease) the low frequency response.
- TREBLE** : Turn this knob clockwise to increase (or counter-clockwise to decrease) the high frequency response.

Note
These controls are effective only for the sound from the main speakers.

■ Using the TONE BYPASS button

Press this button inward (ON) to bypass the tone (**BASS** and **TREBLE**) control circuitry. This function is used for outputting pure sound and checking the tone control settings. The tone control circuitry can be used when this button is released outward (OFF).

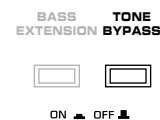

Tuning

Basic operation

Quick automatic-search tuning (automatic tuning) is effective when the station signals are strong with no interference. However, manual tuning can be used during less-than-ideal conditions.

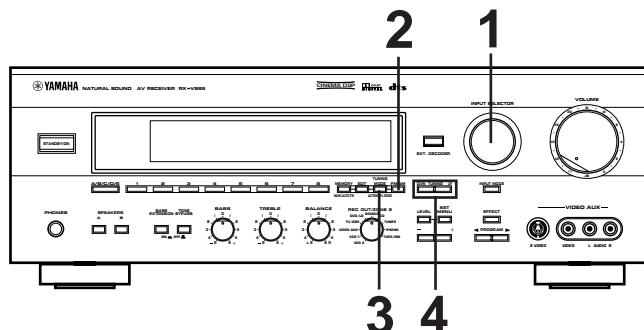

Automatic tuning

- 1** Select "TUNER" as the input source.
- 2** Select the reception band. "FM" or "AM" will be illuminated.
- 3** Turn the "AUTO" indicator off.
- 4** Press the "UP" side once to tune in to a higher frequency. Press the "DOWN" side once to tune in to a lower frequency.

* Press the button again if the tuning search does not stop at the correct station.
 * Use manual tuning if the tuning search does not stop at the correct station because the signals are weak.

Manual tuning

- 1** Select "TUNER" as the input source.
- 2** Select the reception band. "FM" or "AM" will be illuminated.
- 3** Turn the "AUTO" indicator off.
- 4** Tune to the desired station manually.

* Hold down the button to continue the tuning search.

Note
 Manually selecting an FM station will automatically change the reception to monaural to increase the signal quality.

Preset tuning

Manual preset tuning

This unit can store station frequencies selected by the tuning operation. With this function, you can recall any desired station only by selecting the preset station number. Up to 40 stations (8 stations x 5 groups) can be stored.

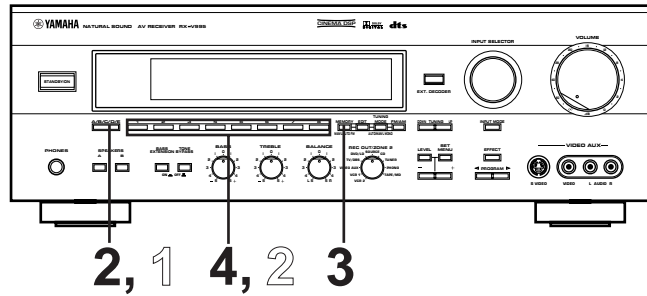

To store stations

- 1 Tune to a station.
(Refer to the previous page for the tuning procedure.)
- 2 Select a group (A – E) of preset stations.
- 3 Select a preset station number (1 to 8) where you want to program the station before the "MEMORY" indicator goes off from the display.

Flashes on and off for about 5 seconds.
- 4 Select a preset station number (1 to 8) where you want to program the station before the "MEMORY" indicator goes off from the display.

A1 FM 90.1 MHz

STEREO AUTO 0 20 100

DVD/LD TV/DBS VALK VCR 1 VCR 2

CD TUNER PHONO TAPE/AUX

Shows the displayed station has been programmed to A1.

* In the same way, program other stations to A2, A3 ... A8.
 * You can program more stations to the preset station numbers on other groups in the same way by selecting other groups in step 2.

To recall a preset station

- 1 Select the group of preset stations.
- 2 Select the preset station number.

Notes

- A new setting can be programmed in place of the former one.
- For presets, the setting of the reception mode (stereo or monaural) is stored along with the station frequency.

Memory back-up

The memory back-up circuit prevents the programmed data from being lost even if this unit is set to the standby mode or the power plug is disconnected from the AC outlet or the power is cut due to a temporary power failure. If, however, the power is cut for about two weeks, the memory may be deleted. If so, it can be re-programmed by simply following the Preset tuning steps.

Automatic preset tuning

You can make use of an automatic preset tuning function for FM stations. With this function, this unit performs automatic tuning and stores FM stations with strong signals sequentially. Up to 40 stations are stored automatically in the same way as in the manual preset tuning method on page 44.

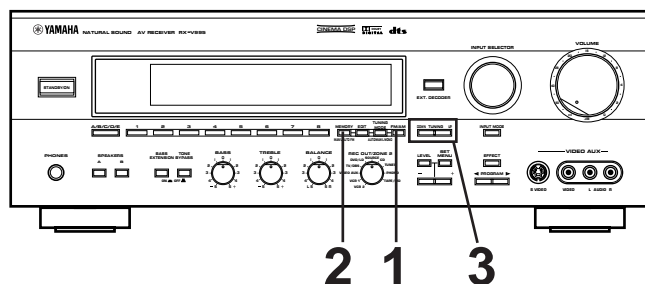

To store stations

1

2 Press and hold for more than 3 seconds

3

To tune to higher frequencies, press the "UP" side once.
To tune to lower frequencies, press the "DOWN" side once.
* If the **TUNING** button is not pressed, in a while, the automatic preset tuning begins automatically toward higher frequencies.

The automatic preset tuning begins from the frequency currently displayed. Received stations are programmed to A1, A2 ... A8 sequentially.
* If more than 8 stations are received, they are also programmed to the preset station numbers on other groups (B, C, D and E) in that order.

If you want to store the first received station to the desired preset station number.

If, for example, you want to store the first received station to C5, select "C5" by using the **A/B/C/D/E** button and the preset station number selector buttons after pressing the **MEMORY** button in step 2. Then press the **TUNING** button. The first received station is stored to C5, and next stations to C6, C7 ... sequentially.

If stations are stored up to E8, the automatic preset tuning is finished automatically.

When the automatic preset tuning is finished

The display shows the frequency of the last preset station. Check the contents and the number of preset stations by following the procedure of the section "To recall a preset station" on page 44.

To recall a preset station

Simply follow the procedure of the section "To recall a preset station" on page 44.

A recalled station is shown by the frequency on the display.

Notes

- You can replace a preset station by another FM or AM station manually by simply following the procedure of the section "To store stations" on page 44.
- If the number of received stations is not enough to be stored up to E8, the search will be finished automatically after searching all frequencies.
- With this function, only FM stations with sufficient signal strength are stored automatically. If the station you want to program is weak in signal strength, tune to it in monaural manually and program it by following the procedure of the section "To store stations" on page 44.

■ Exchanging preset stations

You can exchange the places of two preset stations with each other as shown below.

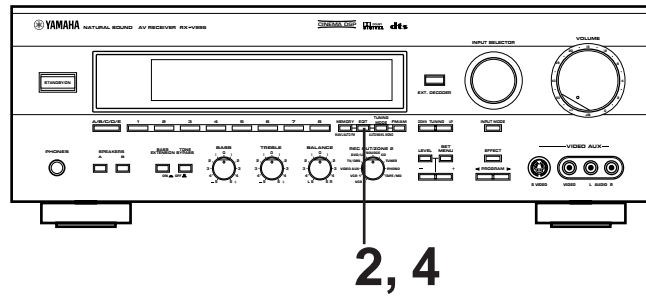

Example)

If you want to exchange the preset stations on E1 and A5 with each other.

<p>1 Recall the preset station on E1 (by following the method of "To recall a preset station" on page 44).</p>	
<p>2</p> <p>Flashes.</p>	<p>4</p> <p>Shows the exchange of stations is completed.</p>
<p>3 Recall the preset station on A5 by following the same method with step 1.</p> <p>Flashes.</p>	

Using digital sound field processor (DSP)

This unit incorporates a sophisticated, multi-program digital sound field processor. The processor allows you to electronically expand and change the shape of the audio sound field from both audio and video sources, creating a theater-like experience in your listening room. You can create an excellent audio sound field by selecting a suitable sound field program (this will, of course, depend on what you will be listening to), and adding desired adjustments.

In addition, this unit incorporates a Dolby Digital decoder and a Dolby Pro Logic Surround decoder for multi-channel sound reproduction of sources encoded with Dolby Surround, and a DTS decoder for multi-channel sound reproduction of sources encoded with DTS. The operation of these decoders can be controlled by selecting a corresponding DSP program including a combined operation of YAMAHA DSP and Dolby Digital, Dolby Pro Logic Surround or DTS.

This unit has 10 programs for digital sound field processing; 5 programs for Audio sources and 5 programs for Audio/Video sources. In addition, some programs have two subprograms. All programs contain parameters that can be adjusted to the listener's taste.

For details about digital sound field programs, refer to pages 52 to 55.

Playing a source with an effect of the digital sound field processor (DSP)

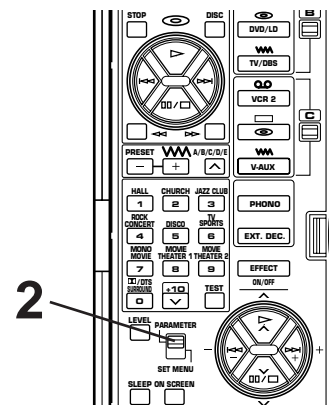
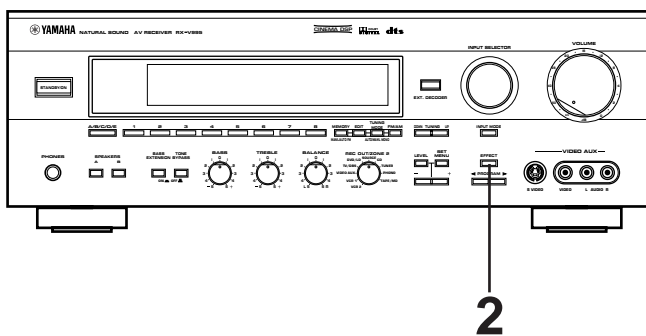

1 Follow steps 1 to 7 shown in "Playing a source" on pages 35 to 36.

2 When operating on the front panel:

If no program name is illuminated on the display panel, press the **EFFECT** button to turn on the digital sound field processor so that a name of a DSP program appears on the display panel and the monitor screen.



When operating on the remote controller:

Set the **PARAMETER/SET MENU** switch to the **PARAMETER** position.

Note: The cover of the remote controller must be open.

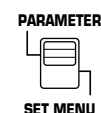

CONTINUED

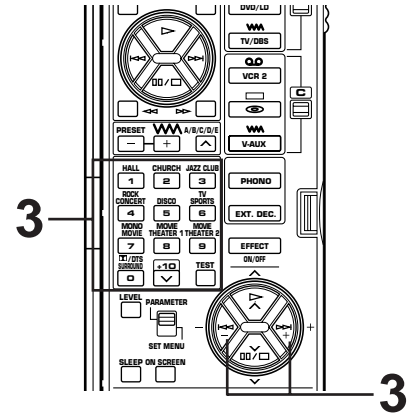
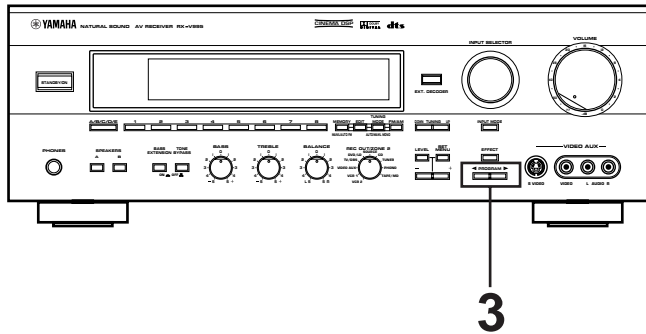

3 Select a program that is suitable for the source.

When operating on the front panel:

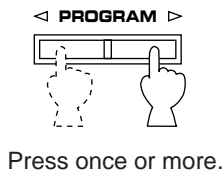

When operating on the remote controller:

a)

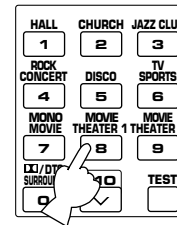

b) For the programs No. 8, 9 and 10 only, you can select the desired subprogram by pressing the corresponding DSP program selector key once or more.

The name of the selected program appears on the display panel and the monitor screen.



Program name



Subprogram name

Program name

- 4**
- Adjust the output level of each speaker. (For details, refer to the corresponding descriptions on pages 50 and 51.)
 - You can create your own sound field taste. (For details, refer to pages 60 to 64.)

Notes

- Program selection can be made to individual input sources. Once you select a program, it is linked with the input source selected at this time. So, when you select the same input source the next time, the same program will be automatically recalled.
- If you prefer to cancel the DSP, press the **EFFECT** button. The sound will be the normal 2-channel stereo without surround sound effect.
- When a monaural sound source is played with the program **PRO LOGIC (Normal/Enhanced)**, a proper effect will not be obtained. Moreover, sound may become unnatural depending on the settings of the speaker output modes (1. CENTER SPEAKER to 4. LFE/BASS OUT) in the SET MENU mode.
- When this unit's Dolby Pro Logic Surround decoder, Dolby Digital decoder or DTS decoder is used, if the main-source sound is considerably altered by overadjustment of the **BASS** or **TREBLE** control, the relationship between the center and rear channels may produce an unnatural effect.
- When a source of signals input to the EXTERNAL DECODER INPUT terminals of this unit is selected, the DSP cannot be used and the **EFFECT** button also will not function.

■ To enjoy a video source encoded with Dolby Pro Logic Surround, Dolby Digital or DTS

When you select the program No. 8, 9 or 10, and the input signal of the source is 2-channel stereo, Dolby Pro Logic Surround is decoded. When some program is selected and the input signal of the source is encoded with Dolby Digital, Dolby Digital is automatically decoded.

When some program is selected and the input signal of the source is encoded with DTS, DTS is automatically decoded.

The following indicators on the display panel show you what sound processing is being made.

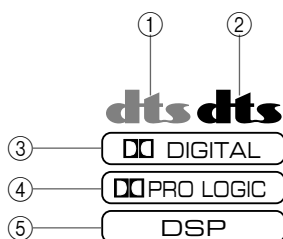

- ① Lights up when a DVD source encoded with DTS is played back and DTS is decoded.
- ② Lights up when an LD source or a CD source encoded with DTS is played back and DTS is decoded.
- ③ Lights up when Dolby Digital is being decoded and the signals of selected source encoded with Dolby Digital is not in 2-channels.
- ④ Lights up when Dolby Pro Logic Surround is being decoded.
- ⑤ Lights up when Digital Sound Field Processor is turned on.

The display panel or the monitor screen will show the selected subprogram according to the type of the decoding.

Notes

- Dolby Digital will not be decoded if the source that is not encoded with Dolby Digital.
DTS will not be decoded if the source that is not encoded with DTS.
- If the input signals of source encoded with Dolby Digital are in 2-channels only, the sound processing for them is similar to that for analog or PCM audio signals.
- **<For China, Singapore and General models only>**
The indicator ③ will also light up when the input mode is set to "D.D.RF" even if no signal encoded with Dolby Digital is input to this unit.

Note

If you change the LD (or CD) being played back with DTS decoded to another disc not encoded with DTS when the red "dts" indicator is illuminated, playing back the newly selected disc will output no sound. In this state, the red "dts" indicator flashes to show that this unit is locked in the DTS-decoding mode.

To play back the disc normally, change the current DTS-decoding mode to another mode by pressing an input selector key on the remote controller or the **INPUT MODE** button on the front panel so that the red "dts" indicator turns off.

■ To cancel the effect sound

The **EFFECT** button on the front panel or the **EFFECT ON/OFF** key on the remote controller make it simple to compare the normal stereo sound with the fully processed effect sound.

To cancel the effect sound and monitor only the main sound, press the **EFFECT ON/OFF** key or the **EFFECT** button. Press the **EFFECT ON/OFF** key or the **EFFECT** button a second time to restore the effect sound.

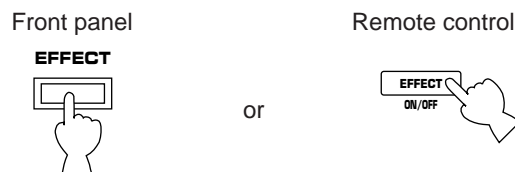

Notes

- If the effect sound is canceled when signals encoded with Dolby Digital or DTS are input to this unit, signals of all channels are mixed and are output from the main speakers.
- If the **EFFECT** button or the **EFFECT ON/OFF** key is pressed to turn effect sounds off when Dolby Digital or DTS is decoded, it may happen that sound is output faintly or not output normally depending on a source. In that case, press the **EFFECT** button or the **EFFECT ON/OFF** key to turn effect sounds ON, or use input signals not encoded with Dolby Digital or DTS.

Adjusting output level of the center, right rear, left rear speakers and subwoofer

You can adjust the sound output level of the each speaker even if the output level is already set in "Speaker balance adjustment" on pages 32 to 34.

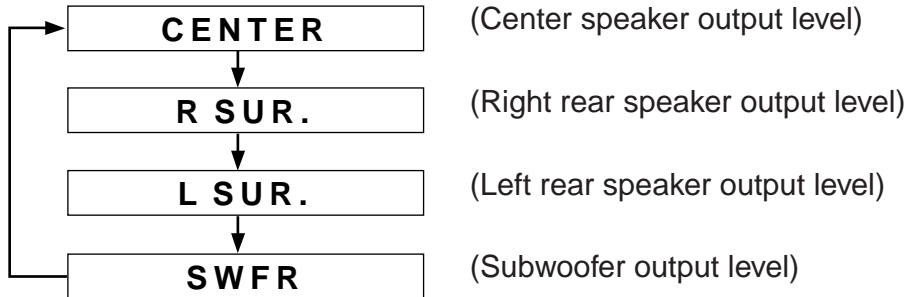

Speakers	Control range (dB)	Preset value
CENTER	MIN, -20 to +10	0
RIGHT SURROUND (R SUR.)	MIN, -20 to +10	0
LEFT SURROUND (L SUR.)	MIN, -20 to +10	0
SUBWOOFER (SWFR)	MIN, -20 to 0	0

Notes

- Once the output level is adjusted, the level value will be the same in all the digital sound field programs.
- The value of each speaker output level you set the last time will remain memorized even when this unit is in the standby mode.
However, if the power cord is disconnected for more than one week, these values will be automatically changed to the factory default settings.
- If the function "1. CENTER SPEAKER" in the SET MENU mode is set in the "NONE" position, the center speaker output level cannot be adjusted. This is because, in this mode, the center sound is automatically output from the left and right main speakers.
- When one of the DSP programs No. 1 to 5 is selected, the center speaker output level cannot be adjusted.

Method of adjustment

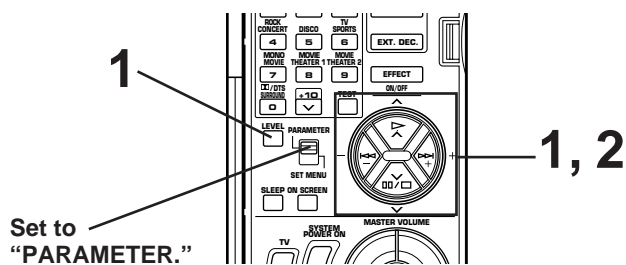
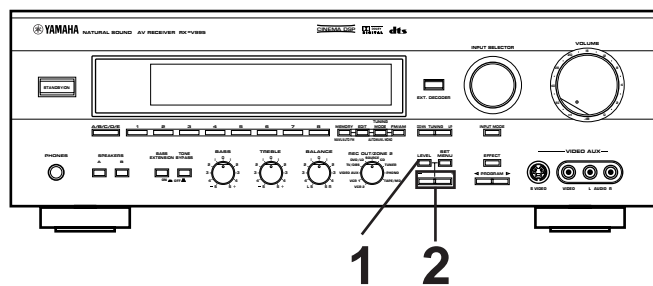

When using the remote controller, set the **PARAMETER/SET MENU** switch to the **PARAMETER** position.

Note: The cover of the remote controller must be open.

1 Select the speaker(s) whose level you want to adjust by using one of the following methods.

When operating on the front panel:

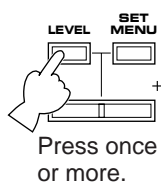

When operating on the Remote controller:

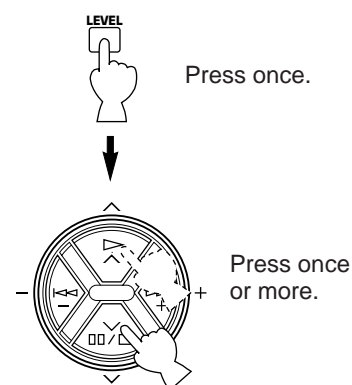

Press a button repeatedly until the name of the desired speaker(s) appears on the display.

2 Adjust the level on the selected speaker(s).

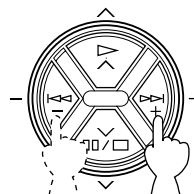
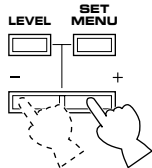

3 Repeat steps 1 and 2 to make adjustments on the other speaker(s).

Brief overview of digital sound field programs

The following list gives you a brief description of the sound fields produced by each of the DSP programs. Keep in mind that most of these are precise digital recreations of actual acoustic environments. The data for these sound fields were recorded at actual locations using sophisticated sound field measurement equipment.

Note
The channel level balance between the left and right rear effect speakers may vary depending on the sound field you are listening in. This is due to the fact that most of these sound field recreations are actual acoustic environments.

■ Program No. 1 to 5: Hi-Fi DSP programs (for audio sources)

- When the input signal is analog or PCM audio: (DSP)
 Speaker output: main, rear
- When the input signal is encoded with the Dolby Digital (not in 2 channels): (DIGITAL DSP)
 Speaker output: main, center, rear
- When the input signal is encoded with the DTS: (**dts** DSP)
 Speaker output: main, center, rear

No.	PROGRAM	FEATURE
1	CONCERT HALL	In this program, the center will appear to be deep behind the main speakers, creating an expansive large hall ambience. Orchestra and opera music are suited for this sound field.
2	CHURCH	This program recreates the acoustic environment of a big church with a high pointed dome and columns along the sides. This interior produces very long reverberations.
3	JAZZ CLUB	This is a small, cozy jazz club with a low ceiling. The sound is very close and intimate.
4	ROCK CONCERT	This program is ideally suited for rock music. You will experience a very dynamic or lively sound field.
5	DISCO	This program recreates the acoustic environment of a lively disco in the heart of a very lively city. The sound is dense and highly concentrated. It is also characterized by a high-energy, "immediate" sound.

■ Program No. 6 to 10: CINEMA-DSP programs (for Audio/Video sources)

- These programs use the Dolby Pro Logic decoder, the Dolby Digital decoder or the DTS decoder.
- Speaker output: main, center, rear
Note: If the "NONE" position is selected on "1. CENTER SPEAKER" in the SET MENU mode, no sound is output from the center speaker(s).
- For program No. 6 and 7 only, indicators light up as follows.

When the input signal is analog or PCM audio: (DSP)

When the input signal is encoded with the Dolby Digital (not in 2 channels): (DIGITAL DSP)

When the input signal is encoded with the DTS: (**dts** DSP)

No.	PROGRAM	FEATURE
6	TV SPORTS	This program is furnished with a tight sound field in which the sound will not spread excessively on the front side, but the rear surround side produces a dynamic sound expansion. This program is the most suitable for sports programs.
7	MONO MOVIE	This program is designed specifically to enhance mono source programs. Compared to a strictly mono setting, the sound image created in this mode is wider and slightly forward of the speaker pair, lending an immediacy to the overall sound. It is particularly effective when used with old mono movies, news broadcasts and dialog.

- Program No. 8 to 9 are suitable for reproducing video discs, video tapes and similar sources which are encoded with Dolby Surround (bearing the "DOLBY SURROUND" or "DOLBY DIGITAL" logo) or encoded with DTS (bearing the "dts" logo).

No.	PROGRAM	SUBPROGRAM (TYPE)	FEATURE
8	MOVIE THEATER 1	<p>70 mm Spectacle (<input checked="" type="checkbox"/> PRO LOGIC <input type="checkbox"/> DSP) Functions when the input signal is analog or PCM audio or encoded with Dolby Digital in 2 channels.</p> <p>DGTL Spectacle (<input checked="" type="checkbox"/> DIGITAL <input type="checkbox"/> DSP) Functions when the input signal is encoded with Dolby Digital not in 2 channels.</p> <p>DTS Spectacle (dts <input type="checkbox"/> DSP) Functions when the input signal is encoded with DTS.</p>	<p>Creates the extremely wide sound field of a movie theater. It precisely reproduces the source sound in detail, giving both the video and the sound field incredible reality. Any kind of video sources encoded with Dolby Surround or DTS (especially large-scale movie productions) are ideal for use with this program.</p>
		<p>70 mm Sci-Fi (<input checked="" type="checkbox"/> PRO LOGIC <input type="checkbox"/> DSP) Functions when the input signal is analog or PCM audio or encoded with Dolby Digital in 2 channels.</p> <p>DGTL Sci-Fi (<input checked="" type="checkbox"/> DIGITAL <input type="checkbox"/> DSP) Functions when the input signal is encoded with Dolby Digital not in 2 channels.</p> <p>DTS Sci-Fi (dts <input type="checkbox"/> DSP) Functions when the input signal is encoded with DTS.</p>	<p>Clearly reproduces dialog and sound effects in the latest sound design of science fiction films, thus creating a broad and expansive cinematic space amid the silence. You can enjoy science fiction films in a virtual-space sound field that includes Dolby Pro Logic, Dolby Digital and DTS-encoded software employing the most advanced techniques.</p>
9	MOVIE THEATER 2	<p>70 mm Adventure (<input checked="" type="checkbox"/> PRO LOGIC <input type="checkbox"/> DSP) Functions when the input signal is analog or PCM audio or encoded with Dolby Digital in 2 channels.</p> <p>DGTL Adventure (<input checked="" type="checkbox"/> DIGITAL <input type="checkbox"/> DSP) Functions when the input signal is encoded with Dolby Digital not in 2 channels.</p> <p>DTS Adventure (dts <input type="checkbox"/> DSP) Functions when the input signal is encoded with DTS.</p>	<p>Ideal for precisely reproducing the sound design of the newest multi-track films. The sound field is made to be similar to that of the newest movie theaters, so the reverberations of the sound field itself are restrained as much as possible. The data of the sound field of an opera house are used for the front presence side, so the three dimensional feeling of the sound field is emphasized, and dialog is precisely oriented on the screen. By using the data of the sound field of a concert hall on the rear surround side, powerful reverberations are generated. You can enjoy watching action, adventure movies, etc. with much presence.</p>
		<p>70 mm General (<input checked="" type="checkbox"/> PRO LOGIC <input type="checkbox"/> DSP) Functions when the input signal is analog or PCM audio or encoded with Dolby Digital in 2 channels.</p> <p>DGTL General (<input checked="" type="checkbox"/> DIGITAL <input type="checkbox"/> DSP) Functions when the input signal is encoded with Dolby Digital not in 2 channels.</p> <p>DTS General (dts <input type="checkbox"/> DSP) Functions when the input signal is encoded with DTS.</p>	<p>This program is for reproducing sounds on a multi-track film, and characterized by a soft and extensive sound field. The front presence side of the sound field is relatively narrow. It spatially spreads all around and toward the screen, restraining echo effect of conversations without losing clarity. For the surround side, the harmony of music or chorus sounds beautifully in a wide space at the rear of the sound field.</p>

- Program No. 10 is for reproducing video discs, video tapes and similar sources which are encoded with Dolby Surround (bearing the “DOLBY SURROUND” or “DOLBY DIGITAL” logo) or encoded with DTS (bearing the “dts” logo).

No.	PROGRAM	SUBPROGRAM (TYPE)	FEATURE
10	DOLBY SURROUND /DTS	<p>PRO LOGIC/Normal (<input checked="" type="checkbox"/> PRO LOGIC) Functions when the input signal is analog or PCM audio or encoded with Dolby Digital in 2 channels.</p> <p>DOLBY DIGITAL/Normal (<input checked="" type="checkbox"/> DIGITAL) Functions when the input signal is encoded with Dolby Digital not in 2 channels.</p> <p>DTS DIGITAL SUR./Normal (dts) Functions when the input signal is encoded with DTS.</p> <hr/> <p>PRO LOGIC/Enhanced (<input checked="" type="checkbox"/> PRO LOGIC <input type="checkbox"/> DSP) Functions when the input signal is analog or PCM audio or encoded with Dolby Digital in 2 channels.</p> <p>DOLBY DIGITAL/Enhanced (<input checked="" type="checkbox"/> DIGITAL <input type="checkbox"/> DSP) Functions when the input signal is encoded with Dolby Digital not in 2 channels.</p> <p>DTS DIGITAL SUR./Enhanced (dts <input type="checkbox"/> DSP) Functions when the input signal is encoded with DTS.</p>	<p>The built-in Dolby Pro Logic Surround decoder, the Dolby Digital decoder or the DTS decoder precisely reproduces sounds and sound effects of a source encoded with Dolby Surround or DTS. The realization of a highly efficient decoding process improves crosstalk and channel separation and makes sound positioning smoother and more precise.</p> <hr/> <p>Ideally simulates the multi-surround speaker systems of the newest film theater. The digital sound field processing and the Dolby Surround decoding or the DTS decoding are precisely performed without altering the originally designed sound orientation. The surround effects produced by this sound field fold the viewer naturally from the rear to the left and right and toward the screen.</p>

ADVANCED FEATURES

“SET MENU” mode

The following 13 functions maximize the performance of your system and increase the enjoyment of audio listening and video watching.

- | | | |
|-------------------|---------------------------------|-------------------|
| 1. CENTER SPEAKER | 6. DOLBY DGTL SET LFE LEVEL | 9. CENTER DELAY |
| 2. REAR SPEAKER | 7. DOLBY DGTL SET DYNAMIC RANGE | 10. PARAMETER INI |
| 3. MAIN SPEAKER | 8. DTS SET LFE LEVEL | 11. MEMORY GUARD |
| 4. LFE/BASS OUT | | 12. TV/DBS INPUT |
| 5. MAIN LEVEL | | 13. DIMMER |

Changes and adjustments

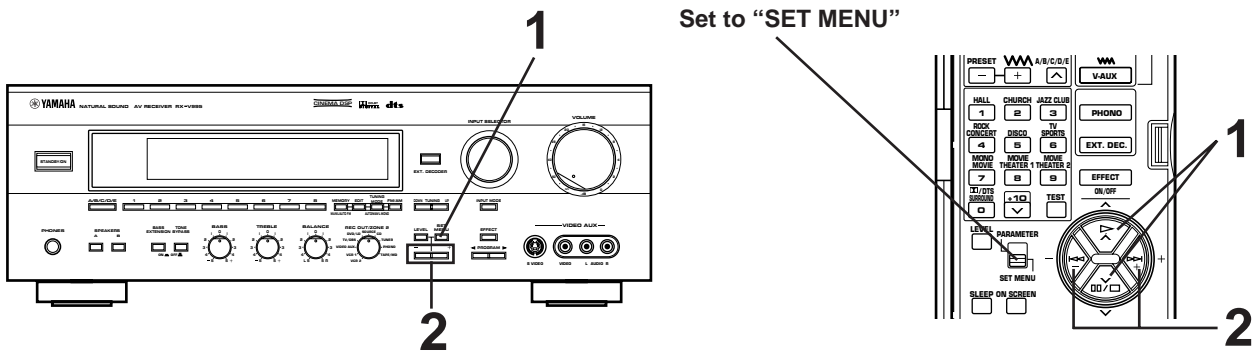

- Refer to the information in the display panel or monitor screen during operation. The monitor power must be turned on to display information on the monitor.
- When using the remote controller, set the **PARAMETER/SET MENU** switch to the SET MENU position.
Note: The cover of the remote controller must be open.

1 To make changes, select the applicable function by using one of the following methods.

When operating on the front panel:

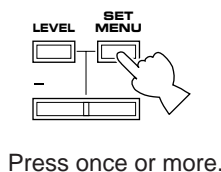

When operating on the Remote controller:

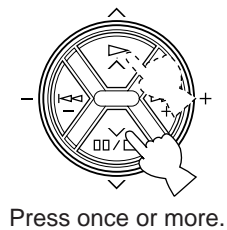

2 Select the desired position or edit parameter for the function by using the following keys.

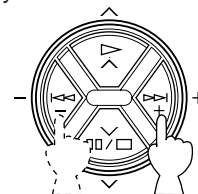
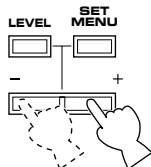

3 Repeat steps 1 and 2 to change a setting or adjust for another function.

■ Function description

- | | | |
|-------------------|-----------------|---------------|
| 1. CENTER SPEAKER | 3. MAIN SPEAKER | 5. MAIN LEVEL |
| 2. REAR SPEAKER | 4. LFE/BASS OUT | |

(Selecting the output modes suitable for your speaker system)

Refer to pages 29 to 30 for details. (Once you have selected proper modes, you do not have to make a setting change, unless your speaker system is modified.)

6. DOLBY DGTL SET LFE LEVEL [Adjusting the output level at the LFE (low frequency effect) channel]

- **Control range:** -20 dB to 0 dB
Preset value: 0 dB
 - This adjustment is effective only when Dolby Digital is decoded and the signals of the selected source encoded with Dolby Digital contain LFE signals.
- Adjusts the output level at the LFE (low frequency effect) channel. If the LFE signals are mixed with signals of other channels and they are output from the same speakers, the ratio of LFE signals to other signals can be adjusted. (Refer to page 5 for details about the LFE channel.)

7. DOLBY DGTL SET DYNAMIC RANGE (Adjusting dynamic range)

- **Choices:** MAX/STD/MIN
Preset position: MAX
- This adjustment is effective only when Dolby Digital is decoded.

“Dynamic range” is the difference between the maximum level and the minimum level of sounds. Sounds on a movie originally designed for movie theaters feature very wide dynamic range.

Dolby Digital technology can bring the original sound track into a home audio format with this wide dynamic range unchanged. Powerful sounds of extremely wide dynamic range are not always suitable for home use. Depending upon the condition of your listening environment, it may not be possible to increase the sound output level as high as a movie theater. However, in a level suitable for listening in your room, the low level parts of source sound cannot be heard well because they will be lost among noises in your environment.

Dolby Digital technology also made it possible to reduce an original sound track’s dynamic range for a home audio format by “compressing” the data of sound.

MAX: In this position, a source encoded with Dolby Digital is reproduced in the original sound track’s wide dynamic range providing you with powerful sounds like a movie theater. Selecting this position will be more ideal if you can listen to a source in a high output level in a room specially soundproofed for audio/video enjoyment.

STD (Standard):

In this position, a source encoded with Dolby Digital is reproduced in the “compressed” dynamic range of the source suitable for low level listening.

MIN:

In this position, dynamic range is more reduced than in the STD position. Selecting this position will be effective when you must listen to a source in an extremely low level.

* In this position, it may happen that sound is output faintly or not output normally depending on a source. In that case, select the MAX or STD position.

8. DTS SET LFE LEVEL [Adjusting the output level at the LFE (low frequency effect) channel]

- **Control range: -10 dB to 10 dB**
Preset value: 0 dB
- This adjustment is effective only when DTS is decoded and the signals of the selected source encoded with DTS contain LFE signals.

Adjusts the output level at the LFE (low frequency effect) channel. If the LFE signals are mixed with signals of other channels and they are output from the same speakers, the ratio of LFE signals to other signals can be adjusted. (Refer to page 5 for details about the LFE channel.)

9. CENTER DELAY [Adjusting the delay of center sounds (dialog etc.)]

- **Control range: 0 ms to 5 ms (in 1 ms step)**
Preset value: 0 ms
- This adjustment is effective only when Dolby Digital or DTS is decoded and the signals of the selected source encoded with Dolby Digital or DTS contain center channel signals.

Adjusts the delay between the main sounds (at the main channels) and dialog etc. (at the center channel). The larger the value, the later the dialog etc. is generated. In your audio system, the distance from the center speaker to your listening position may be shorter than the distance from the left or right main speaker to your listening position. In that case, sounds from the left main, center and right main speakers can reach your listening position at the same time by delaying the sound from the center speaker.

10. PARAMETER INI (Initializing parameters on a DSP program)

You can initialize all parameter settings on a DSP program. Note that some DSP programs have two subprograms; all parameters on both subprograms are initialized by this operation.

Initializing method

Use the remote controller for the operation. A program number whose parameters has been changed is marked with "★". Press a DSP program selector key which corresponds to the program number whose parameters you want to initialize. When initialized, the "★" mark will disappear.

11. MEMORY GUARD (Locking DSP parameters and other adjustments)

If you wish to prevent accidental alteration to DSP parameters and other adjustments on this unit, select "ON". In this position, they are locked and cannot be changed. The following functions on this unit can be locked by this operation.

- DSP parameters
- Other functions in the "SET MENU" mode
- **ON SCREEN** display key
- **LEVEL** key
- **TEST** key

12. TV/DBS INPUT (Selecting the initial input mode of the source connected to the TV/DBS input terminals)

For the source connected to the TV/DBS input terminals of this unit, you can designate the input mode that is automatically selected when the power of this unit is switched on.

AUTO: In this position, the AUTO input mode is always selected when the power of this unit is switched on.

LAST: In this position, the input mode you have selected the last time is memorized and will not be changed even if the power of this unit is switched off.

* Refer to page 38 for details about switching the input mode.

13. DIMMER (Changing brightness of the display panel)

You can adjust the brightness of the display panel in five degree increments.

Creating your own sound fields

What is a sound field?

In order to explain the impressive functions of the DSP, we need to first understand what a sound field really is.

What really creates the rich, full tones of a live instrument are the multiple reflections from the walls of the room. In addition to making the sound “live”, these reflections enable us to tell where the player is situated, and the size and shape of the room in which we are sitting. We can even tell whether it is highly reflective with steel and glass surfaces, or more absorbent with wood panels, carpeting and curtains.

The elements of a sound field

In any environment, in addition to the direct sound coming straight to our ears from the player’s instrument, there are two distinct types of sound reflections that combine to make up the sound field:

(1) **Early Reflections.**

Reflected sounds reach our ears extremely rapidly (50 ms — 100 ms after the direct sound), after reflecting from one surface only—for example, from the ceiling or a wall. These reflections fall into specific patterns as shown in the diagram on page 62 for any particular environment, and provide vital information to our ears. Early reflections actually add clarity to the direct sound.

(2) **Reverberations.**

These are caused by reflections from more than one surface—walls, ceiling, the back of the room—so numerous that they merge together to form a continuous sonic “afterglow”. They are non-directional, and lessen the clarity of the direct sound.

Direct sound, early reflections and subsequent reverberation taken together help us to determine the subjective size and shape of the room, and it is this information that the DSP reproduces in order to create sound fields.

If you could create the appropriate early reflections and subsequent reverberations in your listening room, you would be able to create your own listening environment. The acoustics in your room could be changed to those of a concert hall, a dance floor, or virtually any size room at all. This ability to create sound fields at will is exactly what Yamaha has done with the DSP.

DSP programs consist of some parameters to determine apparent room size, reverberation time, distance from you to the performer, etc. In each program, these parameters are preset with values precisely calculated by Yamaha to create the sound field unique for the program. It is recommended to use DSP programs without changing values of parameters, however, this unit also allows you to create your own sound fields. Starting with one of the built-in programs, you can adjust those parameters. Even if the power cord of this unit is disconnected from the AC outlet, your custom sound fields will remain in the DSP’s memory for about two weeks. The following page details how to make your own sound fields.

Each DSP program has a set of parameters that allow you to change the characteristics of the acoustic environment to precisely create the effect you want. For the programs which have subprograms, each subprogram has a set of parameters. These parameters correspond to the many natural acoustic factors that create the sound field you experience in an actual concert hall or other listening environment. The size of the room, for example, affects the length of time between the “early reflections”—that is, the first few widely spaced reflections you hear after the direct sound. The “ROOM SIZE” parameter provided in many of the DSP programs alters the timing between these reflections, thus changing the shape of the “room” you hear. In addition to room size, the shape of the room and the characteristics of its surfaces have a significant effect on the final sound. Surfaces that absorb sound, for example, cause the reflections and reverberations to die out quicker, while highly reflective surfaces allow the reflections to carry on for a longer period of time. The DSP parameters allow you to control these and many other factors that contribute to your personal sound field, allowing you to essentially “redesign” the concert halls, theaters, etc. provided to create custom-tailored listening environments that ideally match your mood and music.

Refer to “Descriptions of the digital sound field parameters” on pages 62 to 64 for a description of what each parameter does, how it effects the sound, and its control range.

Selecting and editing program parameters

This adjustment can be made only by using the remote controller and watching the monitor screen or the display panel.

Note

Information on the monitor screen would be easier to see than the display panel.

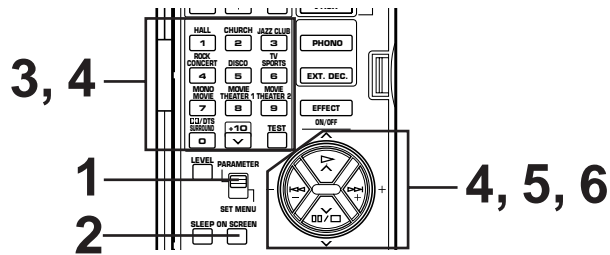

1 Set the **PARAMETER/SET MENU** switch to the **PARAMETER** position.
Note: The cover of the remote controller must be open.

2 Turn your monitor on. If the currently selected type of display is not the full display, press the **ON SCREEN** display key and select the full display.

3 If no DSP program is selected, select a desired program.

The selected program name and its parameters will be displayed on the monitor screen. The arrow-shaped cursor points to the first parameter or subprogram name.

P08 MOVIE THEATER 1

→ **70mm Spectacle** — Subprogram

P. INIT. DLY ··· 15ms

P. ROOM SIZE ··· 1. 0

S. DELAY ····· 23ms

S. ROOM SIZE ··· 1. 0

4 If necessary, select the desired subprogram.

Press the button for the currently selected program once or more.

5 Select the parameter which you want to edit.

6 Change the value on the selected parameter to create the effect you want.

“+” increases the value of the selected parameter, and “-” decreases the value of the selected parameter. In both cases you can hold the key down to quickly move to the desired value. The display will pause for a moment at the initial set value of the parameter as a reminder. (On the monitor screen, the * mark at the head of the parameter name will disappear upon reaching the initial set value of the parameter.)

Notes

- For details about parameters, refer to pages 62 to 64.
- Parameter edits made in this way will remain in effect even if power is lost due to a power failure or the power plug is disconnected from the AC outlet for about two weeks, after which all parameters, as well as other adjustments or setting changes on this unit, will return to their initial values or conditions.

■ Descriptions of the digital sound field parameters

Not all of the following parameters are found in every program.

● ROOM SIZE

How it Affects the Sound:

Changes the apparent size of the music venue. The larger the value, the larger the simulated room will sound.

What it Does:

Adjusts the timing between the early reflections. Early reflections are the first group of reflections you hear before the subsequent, dense reverberation begins.

Control Range:

0.1 – 2.0
Standard setting is 1.0.

Changing this parameter from 1 to 2 increases the apparent volume of the room eight times (length, width, and height all doubled).

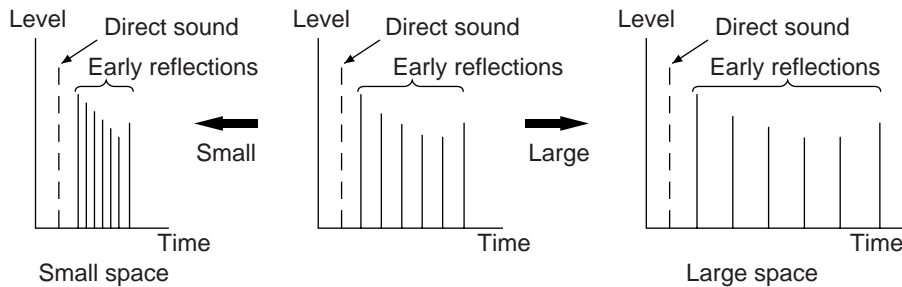

P. ROOM SIZE (Presence Room Size)

Adjusts the apparent space size of the front presence sound field. The larger the value, the longer the interval between reflections becomes, which increases the depth of the sound source.

S. ROOM SIZE (Surround Room Size)

Adjusts the apparent space size of the rear surround sound field. The larger the value, the larger the surround sound field becomes.

● INIT. DELAY (Initial Delay)

How it Affects the Sound:

Changes the apparent distance from the source sound.

Since the distance between a sound source and a reflective surface determines the delay between the direct sound and the first reflection, this parameter changes the location of the sound source within the acoustic environment.

What it Does:

Adjusts the delay between the direct sound and the first reflection heard by the listener.

Control Range:

1 – 99 milliseconds

For a small living room this parameter would be set for a small value. Large values for a big room. Larger values produce an echo effect.

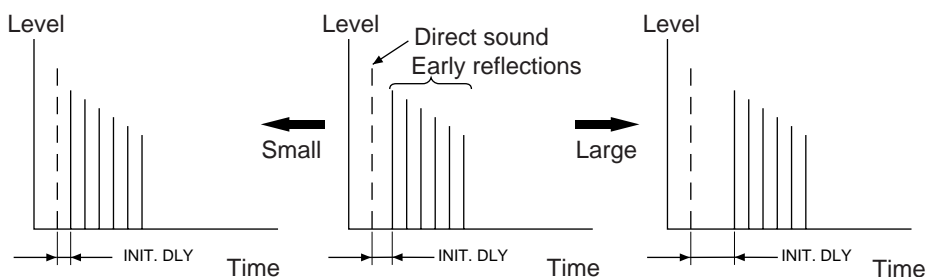

P. INIT. DLY (Presence Initial Delay)

Adjusts the delay between the direct sound and the first reflection on the presence side of the sound field. The larger the value, the later the first reflection begins.

Control Range:

1 – 99 milliseconds

S. INIT. DLY (Surround Initial Delay)

Adjusts the delay between the direct sound and the first reflection on the rear surround side of the sound field. The larger the value, the later the first reflection begins.

Control Range:

1 – 49 milliseconds

● LIVENESS

How it Affects the Sound:

This parameter changes the apparent reflectivity of the walls in the hall.

The early reflections from a sound source will lose intensity (decay) much faster in a room with acoustically absorbent wall surfaces than in one which has mostly reflective surfaces. A room with highly reflective surfaces in which the early reflections decay slowly is termed "live", while a room with absorbent characteristics in which the reflections decay rapidly is termed "dead". The LIVENESS parameter lets you adjust the early reflection decay rate, and thus the "liveness" of the room.

What it Does:

Changes the rate at which the early reflections decay.

Control Range:

0 – 10.

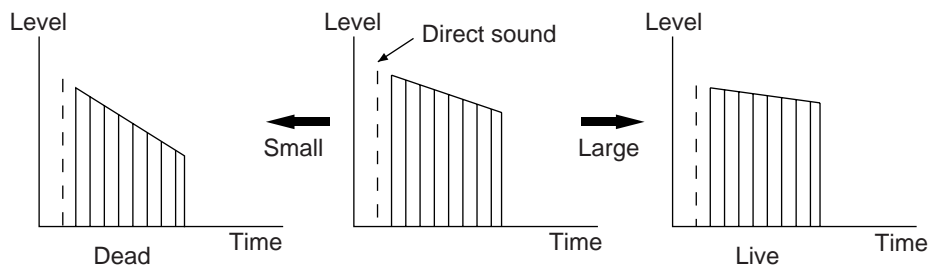

LIVENESS (Presence Liveness)

Adjusts the apparent reflectivity of the walls on the front presence sound field. The larger the value, the more reflective the front presence sound field becomes.

S. LIVENESS (Surround Liveness)

Adjusts the apparent reflectivity of the walls on the rear surround sound field. The larger the value, the more reflective the rear surround sound field becomes.

● REV. TIME (Reverberation Time)

How it Affects the Sound:

The natural reverberation time of a room depends primarily on its size and the characteristics of its inner surfaces. This parameter, therefore, changes the apparent size of the acoustic environment over an extremely wide range.

What it Does:

Adjusts the amount of time it takes for the level of the dense, subsequent reverberation sound to decay by 60 dB (1 kHz).

Control Range:

1.0 – 5.0 seconds.

The reverb time in a small-to-medium size hall would be between 1 and 2, and in a large hall it is normally between 2 and 3.

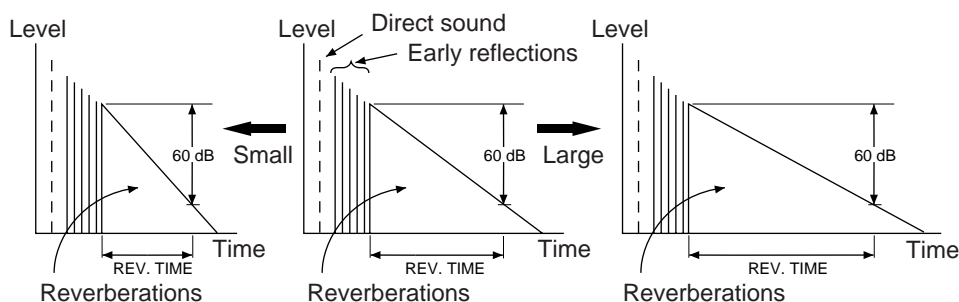

● REV. LEVEL (Reverberation Level)

This parameter adjusts the volume of the reverberation sound. The larger the value, the stronger the reverberation becomes.

Control Range:

0 – 100%

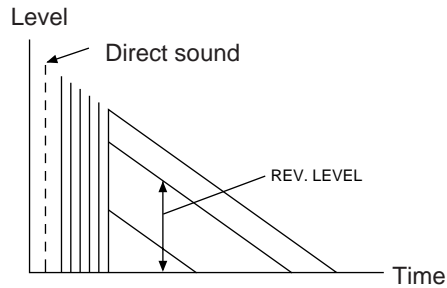

● S. DELAY (Surround Delay)

Adjusts the delay between the direct sound and the first reflection on the rear surround side sound field. The larger the value, the later the surround sound field is generated.

Control Range:

When Dolby Pro Logic Surround is decoded:
15 – 30 milliseconds

When Dolby Digital or DTS is decoded:
0 – 15 milliseconds

When a program without Dolby Surround or DTS
encoded is used:
15 – 49 milliseconds

Setting the SLEEP timer

Use the built-in SLEEP timer to automatically turn this unit into the standby mode after the time you set elapses. The SLEEP timer is useful when you plan to fall asleep while this unit is playing back or recording a source. The SLEEP timer also automatically turns off external units connected to the SWITCHED AC OUTLET(S) on the rear of this unit. The SLEEP timer can only be set using the remote controller.

To set the SLEEP time

- 1** Select the source using the **INPUT SELECTOR** and start playback (or select a broadcast station) on the source unit.
- 2** Press the **SLEEP** key repeatedly until the desired SLEEP time appears on the display.
* "SLEEP time" is the time that elapses before this unit is automatically turned into the standby mode.

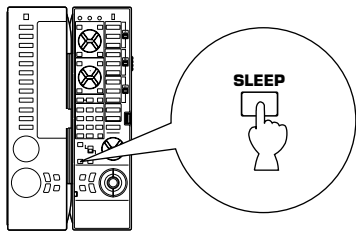

Indicates the SLEEP time.

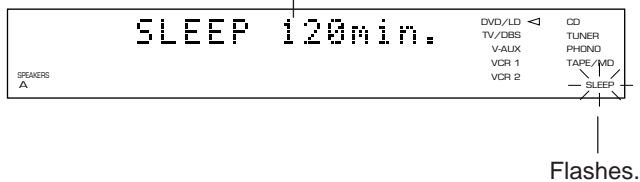

Flashes.

Each time you press the **SLEEP** key, the SLEEP time changes as follows.

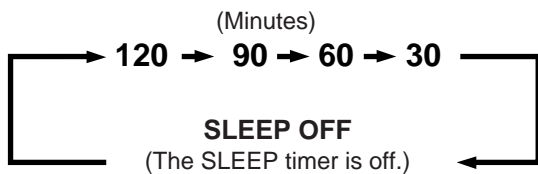

After a while, the display returns to the original indication.

To cancel the SLEEP timer

Press the **SLEEP** key repeatedly until "SLEEP OFF" appears on the display. (After a while, the display returns to the original indication.)

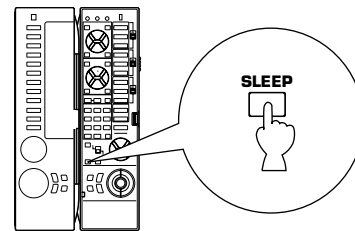

Note

The SLEEP timer setting can also be canceled by setting this unit into the standby mode with the **STANDBY/ON** switch on the front panel (or the **STANDBY** key on the remote controller) or disconnecting the power plug of this unit from the AC outlet.

REMOTE CONTROLLER

The remote controller can operate the main unit as well as other Yamaha audio and video components. The Macro feature allows you to program a series of functions in sequence onto a single key, or you can use one of the preset macros to operate other Yamaha components in your home theater. This remote controller also has a sophisticated Learn feature that allows it to acquire functions from other remote controllers you use with other components in your system (or other household appliances) equipped with infrared remote control receivers. This feature makes it possible for you to reduce the number of remote controllers in your listening room.

Basic operation (Cover is open)

The remote controller is designed to control the most commonly used functions. If the CD player, tape deck, LD player, etc. is a YAMAHA component with remote control compatibility, this remote controller will also control various functions.

* For basic operations, the cover must be opened.

Key name and function

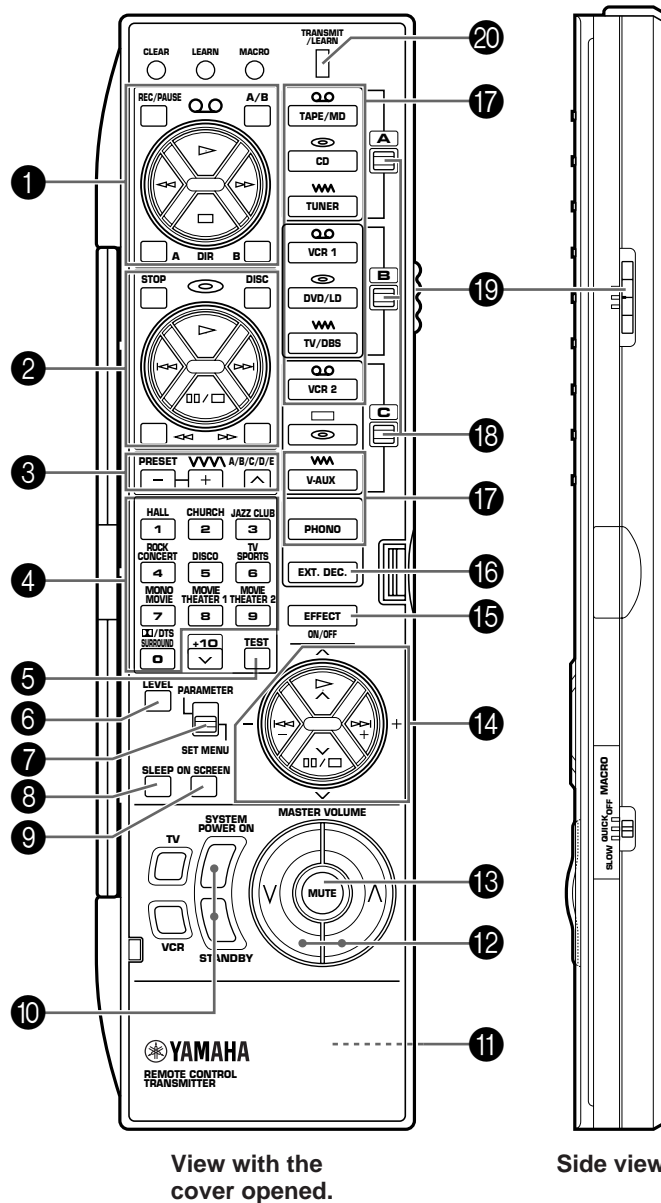

View with the cover opened.

Side view

1 TAPE/MD keys

These keys control tape decks or MD recorders. The A/B/C switch (19) should be set to the "A" position to control tape decks, and "C" position for MD recorders.

- * The **DIR A, B** and **A/B** keys apply only to double cassette tape decks.
- * Pressing the **DIR A** key will reverse the tape direction on a single cassette tape deck with the automatic reverse function.
- * The **◀◀** and **▶▶** keys work as follows.

For tape decks:

- ◀◀ : Rewinds a tape.
- ▶▶ : Advances a tape fast.

For MD recorders:

- ◀◀ : Locates the beginning of the current or previous track.
- ▶▶ : Locates the beginning of the next track.

2 CD/DVD/LD player keys

These keys control compact disc players, DVD players or LD players. Set the A/B/C switch (19) to the "A" position to control compact disc players, "B" position for DVD players and "C" position for LD players.

- * The **DISC** key is used for disc changers only.
- * The **STOP** key is used for DVD players and LD players only.

3 Tuner keys

Control tuners. The A/B/C switch (19) should be set to the "A" position.

- + : Press this key to select the next preset station number.
- : Press this key to select the previous preset station number.

A/B/C/D/E: Selects the group (A – E) of preset station numbers.

4 DSP program selector keys

Press a key to select a DSP program when the built-in digital sound field processor is on. Includes the Dolby Pro Logic Surround decoder, Dolby Digital decoder, and DTS decoder.

5 TEST key

This key is used when adjusting the speaker balance. (Refer to pages 32 to 34.)

6 LEVEL key

This key is used to adjust the output level of the center and rear speakers, and subwoofer. First, press this key (several times) to select the speaker(s). The name will be illuminated on the display. Then press the + or – keys (14) to change the output level.

7 PARAMETER/SET MENU switch

Set this switch to "PARAMETER" to edit a DSP program parameter. Set to "SET MENU" to adjust or make changes in a function in the SET MENU mode.

8 SLEEP timer key

Press this key to turn the built-in SLEEP timer on and off, and set the SLEEP time. (Refer to page 65.)

9 ON SCREEN display key

Press this key to change the type of display on the monitor screen. Three types of displays are available. Each time the key is pressed, the information can be changed to a full, simple and no display.

10 SYSTEM POWER ON and STANDBY keys

Press the **SYSTEM POWER ON** key to turn on the power. Press the **STANDBY** key to set this unit in the standby mode.

11 RESET button

This button is inside the battery compartment. Press this button to reset the internal microcomputer for controlling remote control operations. This button is used when the remote controller "freezes".

- * Learned functions will not be erased when this button is pressed.

RESET button

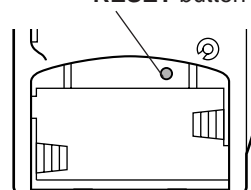

12 MASTER VOLUME ^ (up) and v (down) keys

Press these keys to increase or decrease the volume.

13 MUTE key

Press this key to mute the volume. The volume can be returned to the original level by pressing any remote controller key which controls this unit. The indicator on the **VOLUME** control flashes during the mute mode.

14 ^ / v and -/+ keys

The ^ (up) and v (down) keys change the parameters or functions according to the mode selected by the **PARAMETER/SET MENU** switch. The – and + keys adjust or make changes in the parameter or function.

15 EFFECT ON/OFF key

Press this key to turn on/off the digital sound field processor, which includes the Dolby Pro Logic Surround decoder, Dolby Digital decoder and DTS decoder.

16 EXT. DEC. key

Press this key to select the input signals from the EXTERNAL DECODER INPUT terminals as the input source. This function takes priority over the input selector key setting. "EXT. DECODER" will be illuminated on the display panel. The source selected with the input selector keys becomes the current input source when "EXT. DECODER" is not illuminated on the display panel.

17 Input selector keys

Press a key to select the input source.

18 A/B/C indicators

One of these indicators will turn to red depending on the position of the A/B/C switch.

19 A/B/C switch

Normally this switch is set to the "A" position. Use the "B" position to control a Yamaha DVD player with the CD/DVD/LD player keys (2). Use the "C" position to control a Yamaha LD player with the CD/DVD/LD player keys (2), or control a Yamaha MD recorder with the TAPE/MD keys (1).

20 TRANSMIT/LEARN indicator

This indicator will be illuminated when a key is pressed on the remote controller. (Transmitting infrared signals.)

Note

The functions of the keys to control other Yamaha components are the same as the corresponding keys on those components. Refer to those components' instruction manuals for details.

Using the “learning-capable” keys (Cover is open)

This is a learning remote controller. The shaded keys in the illustration shown below can be programmed to “learn” control functions from other remote controllers. This unit can be used in place of other remote controllers by learning their functions. It will be much convenient for you to operate various audio and video components.

Some of the “learning-capable” keys are originally empty and others have already been preset with functions to control this unit and other Yamaha components. You can store new functions to them (in place of preset functions) as desired.

* See page 74 for the learning method.

* See page 76 for clearing a learned function (or all learned functions).

Note

If the memory capacity of the remote controller becomes full, no further learning is possible even if some learning-capable keys are not occupied with new functions. If, for example, you store Yamaha codes only into this remote controller, up to about 20 functions can be stored. Therefore, we recommend that only required functions be stored.

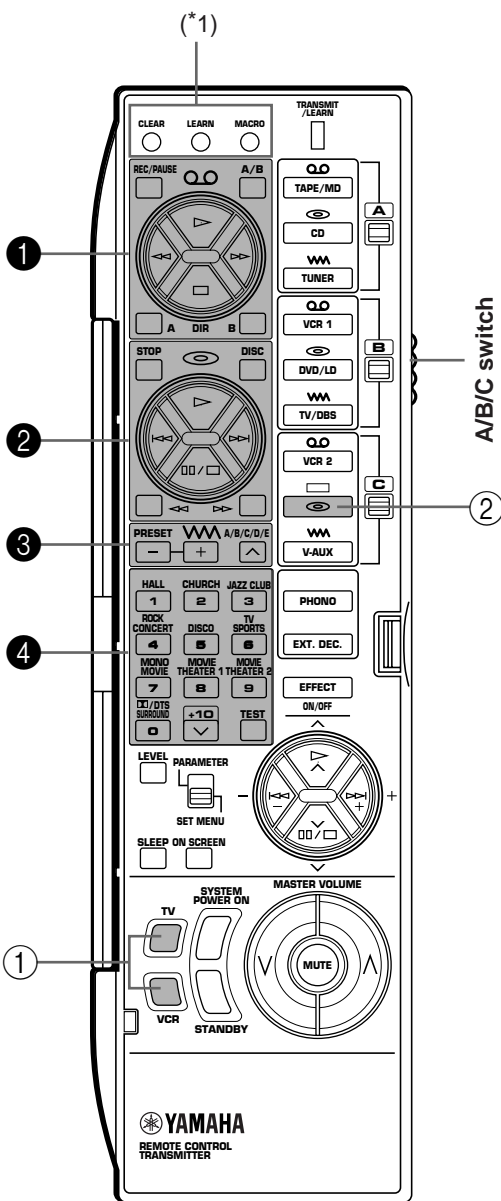

Cover is open.

Keys which can have three functions (1, 2, 3, 4)

In the “Learning-capable” keys, the keys numbered 1–4 in the illustration on the left can have three functions. This is because they have three memory areas (A, B and C). (One function per area.) You can store new functions into the area B and C, and use three functions on a key by switching the memory areas with the **A/B/C switch**. (Area A cannot learn a new function.)

To use these keys:

1. Before using a key, select area A, B or C of the key on which the function you want to use is stored by using the **A/B/C switch**.
2. Press the key.

The default settings of these keys are as follows.

	The position of A/B/C switch		
1 O.O	Preset with functions for controlling a Yamaha tape deck.	Empty	Preset with functions for controlling a Yamaha MD recorder. (A/B, DIR A and B are empty.)
2 O	Preset with functions for controlling a Yamaha CD player. (STOP is empty.)	Preset with functions for controlling a Yamaha DVD player (except the models DVD-1000 and DVD-S700).	Preset with functions for controlling a Yamaha LD player. (DISC is empty.)
3 WM	Preset with functions for controlling the built-in tuner.	Empty	Empty
4 O	Preset as the DSP program selector keys (1–9, 0) and the TEST key. (+10 is empty.)	Preset as the DSP program selector keys (1–9, 0) and the TEST key. (+10 is empty.)	Preset as the DSP program selector keys (1–9, 0) and the TEST key. (+10 is empty.)

(*1): These buttons are used for learning a new function or clearing a learned function (or all learned functions). For details, refer to pages 74 to 76 .

Notes

- Area A cannot learn a new function. To store a new function, store it onto area B or C.
- If a key which has a preset function learns a new function, the preset function will not work but is not deleted. When the learned function is cleared, the preset function is restored. (For information on clearing a learned function, refer to page 76.)

Empty keys (①, ②)

These are empty keys. Each key can learn a function from another remote controller. For example, the **TV** key is useful for storing the function of your TV's power switch, and the **VCR** key can be used for your VCR's power switch.

About the marks on the remote controller

Mark	Meaning
Ⓛ	Tape (Tape deck, VCR, etc.)
Ⓞ	Disc (CD player, LD player, etc.)
Ⓜ	Radio wave (Tuner, TV/BS tuner, etc.)

An input selector key and other control keys which have the same mark will work for the same input source. These marks are also helpful for storing new functions.

Examples)

- Area B of keys ① is suitable for storing functions to control your VCR.
- Area B of keys ③ is suitable for storing functions to control your TV/BS tuner.

To record new functions

It is recommended that you write down stored key functions on the provided user function stickers and paste them on the reverse side of the remote controller or the reverse side of the remote controller's cover.

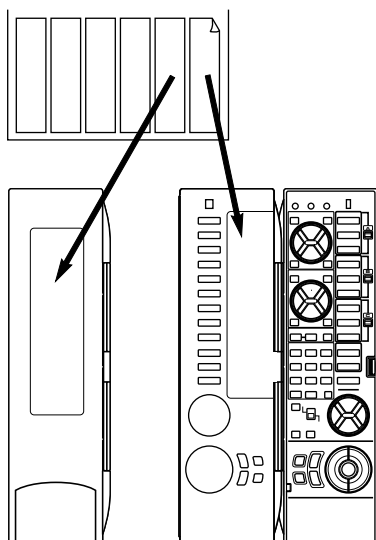

Memory back-up

All of the learned functions will be retained while you replace the batteries. However, if no batteries are installed for a few hours, the learned functions will be erased and will have to be learned again.

Using OPERATION CONTROL keys (Cover is closed)

When the cover of the remote controller is closed, you can easily operate Yamaha components including learned functions by using the **OPERATION CONTROL** keys.

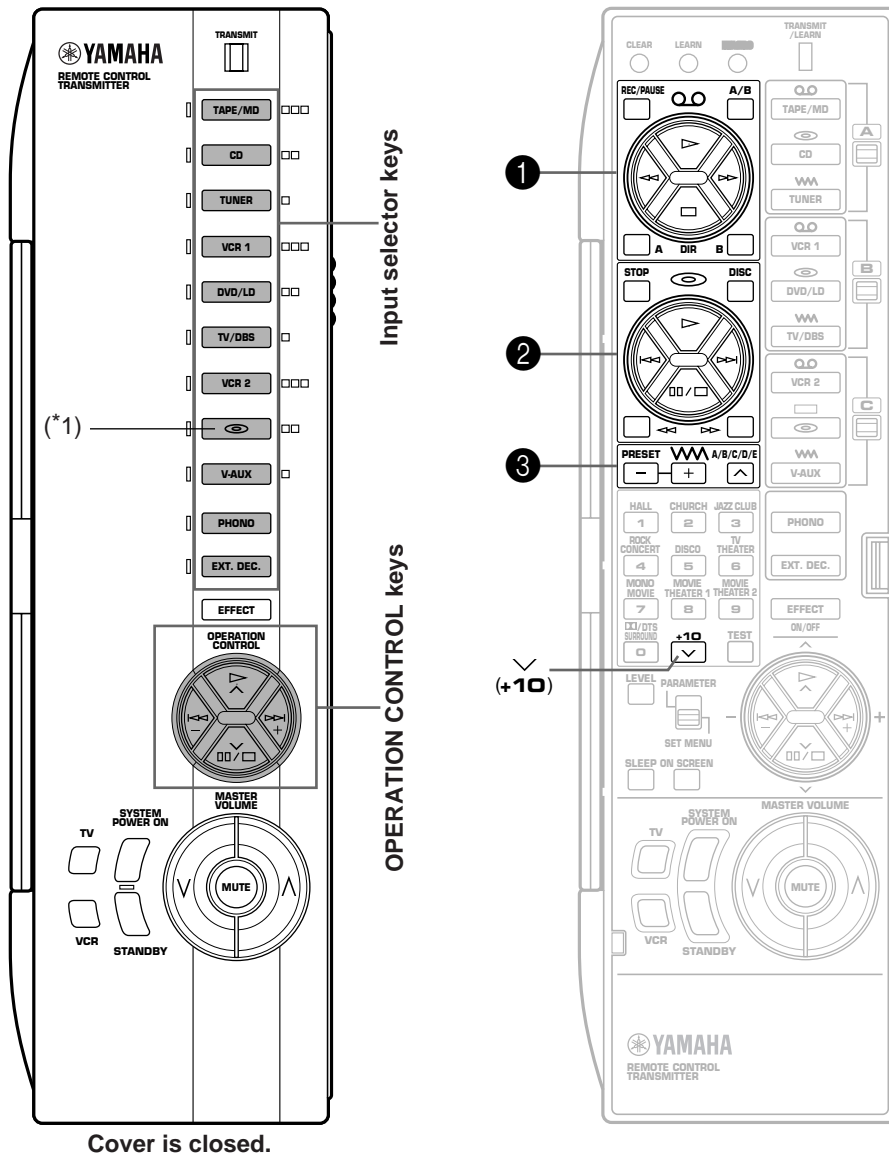

Cover is closed.

When the cover is closed, the **OPERATION CONTROL** keys substitute for the keys numbered ①, ② or ③ and the ✓ (+10) keys on the above illustration. To use these keys, you do not have to switch the A/B/C switch. The functions of the **OPERATION CONTROL** keys are determined by the input selector key pressed before using the **OPERATION CONTROL** keys.

Note

Whether the cover is opened or closed, the **EFFECT**, **MASTER VOLUME**, **MUTE**, **TV** and **VCR** keys will not change their functions.

* If the **MACRO** switch on the side of the remote controller is set to "OFF", the **SYSTEM POWER ON** and **STANDBY** keys will not also change their functions whether the cover is opened or closed.

(*1): This key is originally empty. If this key has a learned function, pressing this key executes the learned function.

Examples of operations controlled by using the OPERATION CONTROL keys

To operate a Yamaha CD player

1. Press the "CD" input selector key.
2. Use the **OPERATION CONTROL** keys. (They carry out the functions in area A of keys ②.)

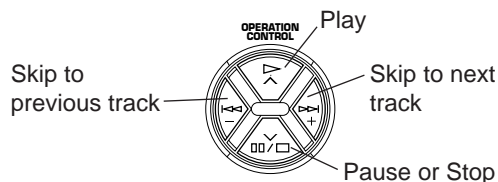

To operate your VCR

1. Press the "VCR" input selector key.
2. Use the **OPERATION CONTROL** keys. (They carry out the functions in area B of keys ①. This area is originally preset with no function. You must store the functions related to controlling the VCR in area B of keys ① beforehand.)

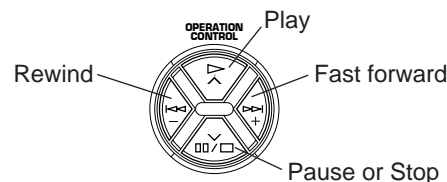

See the table below for a combination of an input selector key and key functions which the **OPERATION CONTROL** keys carry out. (Also, refer to the table on page 68.)

Selected input selector key	Key functions which the OPERATION CONTROL keys carry out
TAPE/MD	Functions in area A of keys ① (except REC/PAUSE, A/B, DIR A and B)
CD	Functions in area A of keys ② (except STOP, DISC, <<< and >>>)
TUNER	Functions in area A of keys ③ and √ (+10)
VCR 1	Functions in area B of keys ① (except REC/PAUSE, A/B, DIR A and B)
DVD/LD	Functions in area B of keys ② (except STOP, DISC, <<< and >>>)
TV/DBS	Functions in area B of keys ③ and √ (+10)
VCR 2	Functions in area C of keys ① (except REC/PAUSE, A/B, DIR A and B)
Ⓜ	Functions in area C of keys ② (except STOP, DISC, <<< and >>>)
V-AUX	Functions in area C of keys ③ and √ (+10)

Pressing the "PHONO" or "EXT. DEC." input selector key has no effect on the **OPERATION CONTROL** keys.

Notes

- If an **OPERATION CONTROL** key is substituted for a key which has no function (empty), then a command will not be carried out. Depending on your plan, store functions from other remote controllers into an empty area of those keys. (Refer to page 74 for the learning method.)
- While playing an audio/video unit, if you want to operate another unit by using the remote controller (for example, if you want to rewind a videotape while listening to a CD), you should open the cover of the remote controller and use the A/B/C switch and the corresponding keys.
(If you press an input selector key with the cover closed to change the functions of the **OPERATION CONTROL** keys to the functions for controlling a VCR, the input of currently playing CD source is canceled.)

Macro operations (Cover is closed)

The Macro feature makes it possible to operate a series of functions by pressing just one key. For example, when you want to play a CD, normally you would turn on the equipment, select the CD input, and press the play key to start playback. Using the Macro feature you can operate all those functions by simply pressing the CD macro key. The preset macro keys (the input selector keys and **SYSTEM POWER ON/STANDBY** keys with an orange mark next to them) are preset with macro programs. If you prefer, however, you can change the contents of a macro key by storing a desired series of functions on it. You can store up to seven functions onto a macro key. (Refer to page 75 for making a new macro.)

Macros can be used only when the cover is closed and the **MACRO** switch is set to "SLOW" or "QUICK". (If "OFF" is selected, no macro will function even if the cover is closed.)

Setting the MACRO switch

OFF: In this position, no macro will function even if the cover of the remote controller is closed.





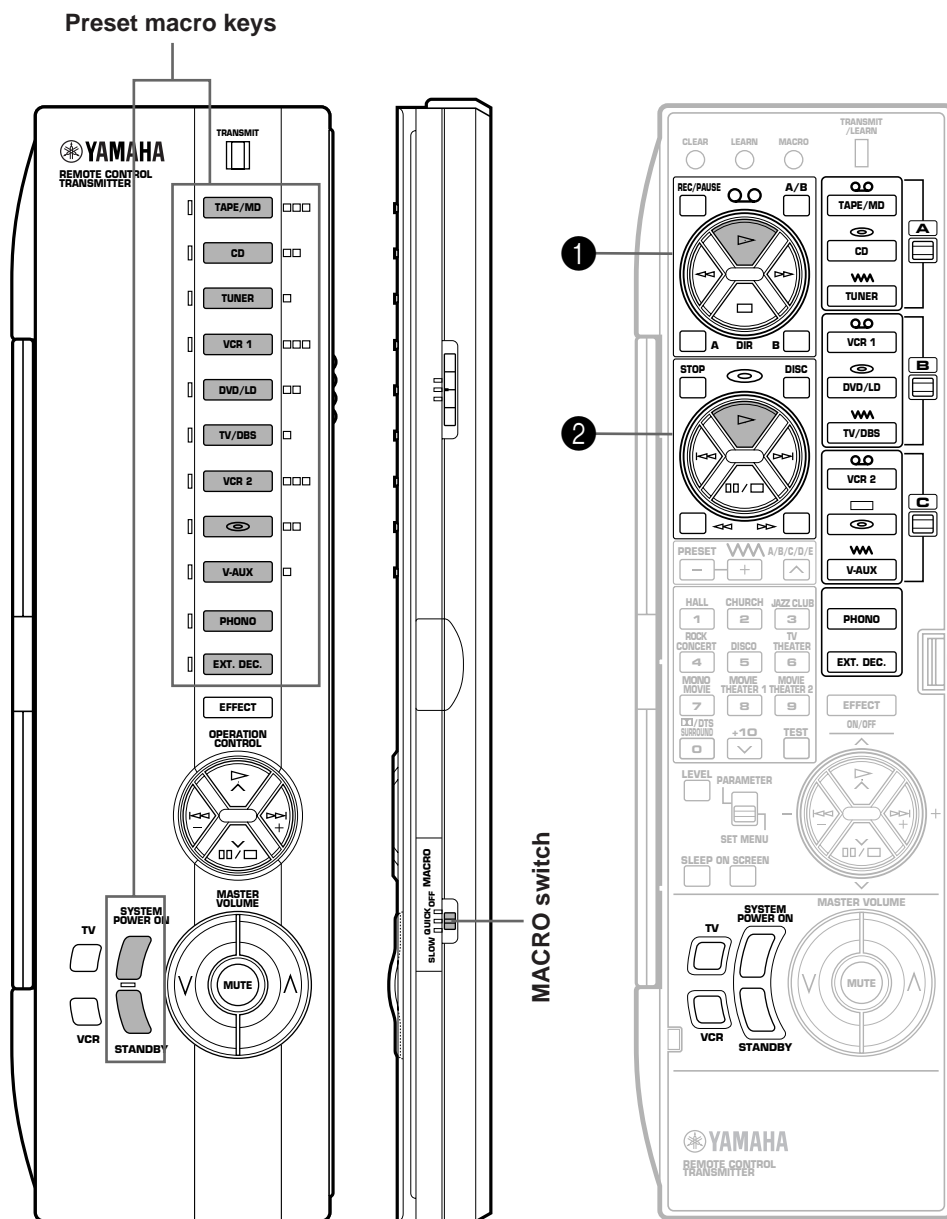

















QUICK: In this position, when a macro key is pressed, each command is transmitted at 0.5 second intervals.







SLOW: In this position, when a macro key is pressed, each command is transmitted at 3 second intervals.



Cover is closed.
(Set the MACRO switch to "QUICK" or "SLOW".)

The Macro feature allows you to operate several remote control functions in a programmed order by pressing one macro key. (Also, refer to the table on page 68.)

Macro key	Function of the key (and area) carried out when a macro key is pressed		
	1st (Turns on this unit.)	2nd (Selects an input source.)	3rd (Starts playback of a source.)
			“▷” on area A of keys ①
			“▷” on area A of keys ②
			—
			“▷” on area B of keys ①
			“▷” on area B of keys ②
			—
			“▷” on area C of keys ①
			“▷” on area C of keys ②
			—
			—
			—

Macro key	Function of the key carried out when a macro key is pressed		
	1st	2nd	3rd
	Turns on this unit. 	Carries out the function of the TV key. 	Carries out the function of the VCR key. 
	Sets this unit to the standby mode. 	—	—

Notes

- A key in which no function is stored will carry out no command.
- If it occurs that this unit will not receive the second command because the internal operation of the first command takes a long time, set the **MACRO** switch to the “SLOW” position.
- Once you press a macro key, this unit will not receive the command of another key (even if it is pressed) until this unit finishes carrying out all commands of the macro key. Take notice of this especially when the **MACRO** switch is in the “SLOW” position.
- Once you press a macro key, you must keep the remote controller directed at the main unit’s remote control sensor until the remote controller finishes transmitting all command signals of the macro key.
- You can also use the **OPERATION CONTROL** keys while using the macro functions.

Methods of learning and clearing functions

■ Learning a new function

- 1** Place this remote controller and the other remote controller so that they face each other.

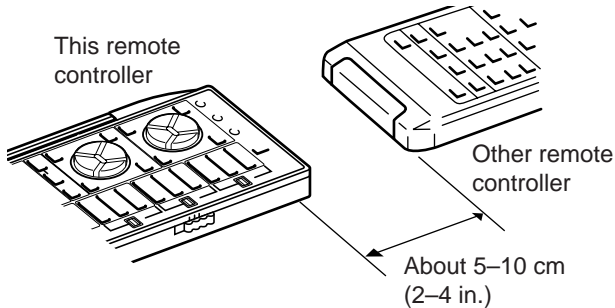

- 2**
-
- (Press by using a ball-point pen or similar object.)
- Flashes slowly.

- * If there is no operation for about 30 seconds after the **LEARN** button is pressed, the TRANSMIT/LEARN indicator flashes rapidly and the current mode is canceled. Repeat this step.

- 3** If necessary, select the memory area by using the A/B/C switch on the side panel of the remote controller.

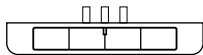

- 4** Press the key on this remote controller in which you will store a new function.

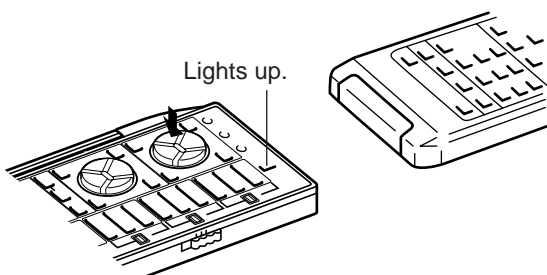

- * If a key which cannot learn another function is pressed, the TRANSMIT/LEARN indicator flashes rapidly and the current mode is canceled. Repeat this step.
- * If there is no operation for about 30 seconds after a key is pressed, the TRANSMIT/LEARN indicator flashes rapidly and the mode before you began learning operations is restored. Restart from step 2.

- 5** Press and hold the key (on the other remote controller) which has the function you want to store.

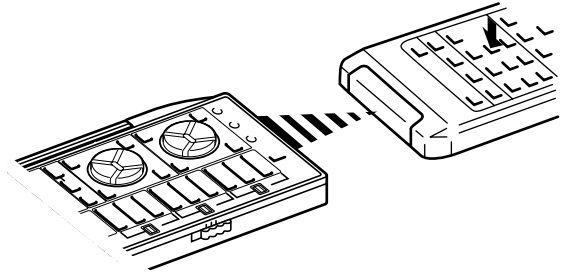

When learning is finished, the TRANSMIT/LEARN indicator stops lighting. You can release the key. Then the indicator begins flashing slowly.

- * If a signal is not successfully received, the TRANSMIT/LEARN indicator flashes rapidly and the mode prior to step 4 is restored. Restart from step 4.
- * If memory capacity is full, the TRANSMIT/LEARN indicator flashes rapidly to show you that learning is impossible, and then the mode before you began learning operations is restored.

- 6** Repeat steps 3-5 to store more functions.

- 7** When you finish the learning operation, press the **LEARN** button.

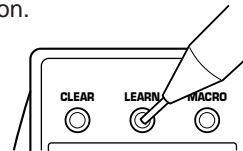

Notes

- Newly learned functions will replace previously learned functions.
- If there is no more room in the memory area for a function to be learned, the TRANSMIT/LEARN indicator will flash rapidly. In this case, even if some keys are not occupied with functions from other remote controllers, no further learning is possible.
- If you close the cover while learning, and then about 5 seconds pass, the TRANSMIT/LEARN indicator flashes rapidly and the mode before beginning learning operations is restored. Restart from step 2. However, if you open the cover within 5 seconds, the mode before closing the cover is restored.
- There may occasionally be instances in which, due to the signal-coding and modulation employed by the other remote controller, this remote controller will not be able to "learn" its signals.
- When you press the **LEARN**, **MACRO** or **CLEAR** button, or the **RESET** button inside of the battery compartment by using a sharp-pointed thing, be careful not to damage the button. If you will use a mechanical pencil, make sure that the lead is retracted.

■ Making a new macro

A new macro can be programmed onto any preset macro key in place of the factory preset functions. (See page 72 to know what keys are preset macro keys.) You can make as many as 13 new macro keys. A macro key can learn as many as seven functions of other keys.

Note
If you store a continuous function such as lowering the volume level, it may not work well when carried out as a part of macro.

1

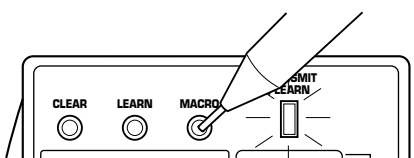

Flashes slowly.

* If there is no operation for about 30 seconds after the **MACRO** button is pressed, the **TRANSMIT/LEARN** indicator flashes rapidly and the mode before you pressed the **MACRO** button is restored. Press the **MACRO** button again.

2 Press a preset macro key on which you want to make a new macro.

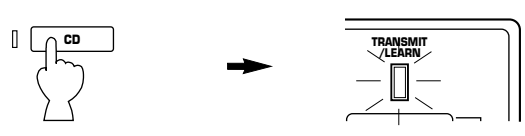

Lights up.

* If a key other than a preset macro key is pressed, the **TRANSMIT/LEARN** indicator flashes rapidly and the current mode is canceled. Repeat this step.

3 Press a key whose function you want to store as the first function of the new macro.

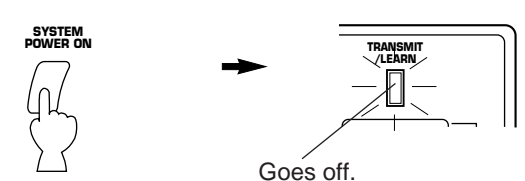

Goes off.
(When learning is finished, this indicator lights up again.)

* If a key whose function cannot be stored as a command of macro is pressed, the **TRANSMIT/LEARN** indicator flashes rapidly and the current mode is canceled. Repeat this step.
* If about 30 seconds pass before a key is pressed, the **TRANSMIT/LEARN** indicator flashes rapidly and the mode before you began learning operations is restored. Restart from step 1.

4 Repeat step 3 to store the second, the third and more functions. You can store up to seven key functions in series as a macro.

* If the seventh key function has been learned, the **TRANSMIT/LEARN** indicator flashes rapidly and the mode before you began learning operations is restored. (This shows that the key has completed learning a series of functions as a macro.) You do not have to follow the next step.

5 When you finish learning, press the **MACRO** button.

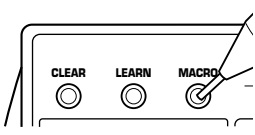

Notes

- If, for example, you store a function whose operation takes a long time as the first command, add a command which has no function between the first command and the second command, or repeat the second command again.
- If you program the power on/off switching function of TV, VCR, etc. as a part of a macro sequence, note that it switches the current mode to the other ("on" to "off", or "off" to "on").
For example, when you press the macro key, if the power of TV, VCR, etc. is already on, the power will be turned off even though you may not want it to do so.

■ Clearing learned functions

To Clear a Learned Function

- 1 To clear a learned key function, press the **LEARN** button using a ball-point pen or similar object. To clear a macro you made, press the **MACRO** button.

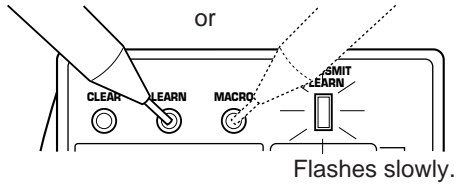

- 2 Press and hold the **CLEAR** button using a ball-point pen or similar object.

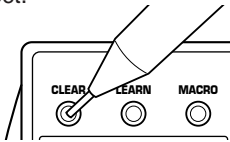

- 3 Holding the **CLEAR** button pressed, press and hold the key whose function you want to clear until the indicator flashes 3 times.

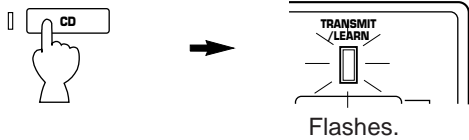

To clear two or more functions sequentially, do not release the **CLEAR** button, and repeat this step.

Note

If you clear a learned function of a key, the key is restored by the originally preset function. (except the keys which are originally preset with no function.)

To Clear All Learned Functions

- 1 Select the kind of key functions all of which you want to clear by using the **MACRO** switch on the side panel of the remote controller.

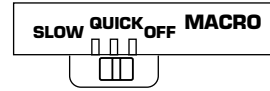

- OFF:** Select this position if you want to clear all of the learned functions except macros.
- QUICK:** Select this position if you want to clear all of the macros you made.
- SLOW:** Select this position if you want to clear all of the learned functions including macros.

- 2 Press the **CLEAR** button using a ball-point pen or similar object.

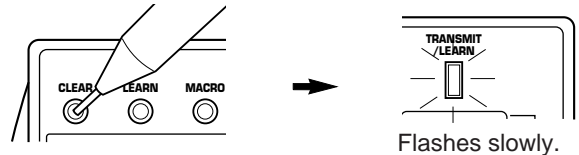

- * If one of the following is made after you press the **CLEAR** button, the TRANSMIT/LEARN indicator flashes rapidly and the current mode is canceled. Press the **CLEAR** button again.

- **MACRO** switch is switched to another position.
- Another key is pressed.
- There is no operation for about 30 seconds.

- 3 Press and hold the **CLEAR** button again. While holding down the **CLEAR** button, press and hold the **MASTER VOLUME** \wedge and \vee keys simultaneously until the indicator flashes 7 times.

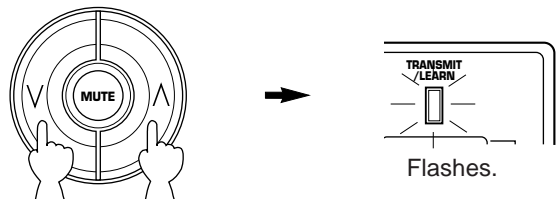

CUSTOM INSTALLATION GUIDE

You can make up a dual-room audio/video system with this unit. In this system, you can make this unit send audio and video signals to the main room's equipment (speakers and TV monitor) and the second room's equipment (amplifier and TV monitor) respectively. For example, you can enjoy listening to a CD source in the main room while another person is enjoying watching an LD source in the second room.

Connections

The following optional products are required to use the dual-room function.

- ① An infrared emitter in the main room
This emitter emits the infrared signals transmitted by the remote controller in the second room to the other components in the main room (for example, CD player or LD player).
- ② An amplifier, TV monitor and speakers for the second room
- ③ A remote controller used in the second room
- ④ An infrared signal receiver for the second room

Connect the ZONE 2 OUT audio output terminals of this unit to the MAIN IN terminals (or equivalents) of the amplifier in the second room, and connect the ZONE 2 OUT video output terminal of this unit to the video signal input terminal of the TV monitor in the second room.

Example of system configuration and connections

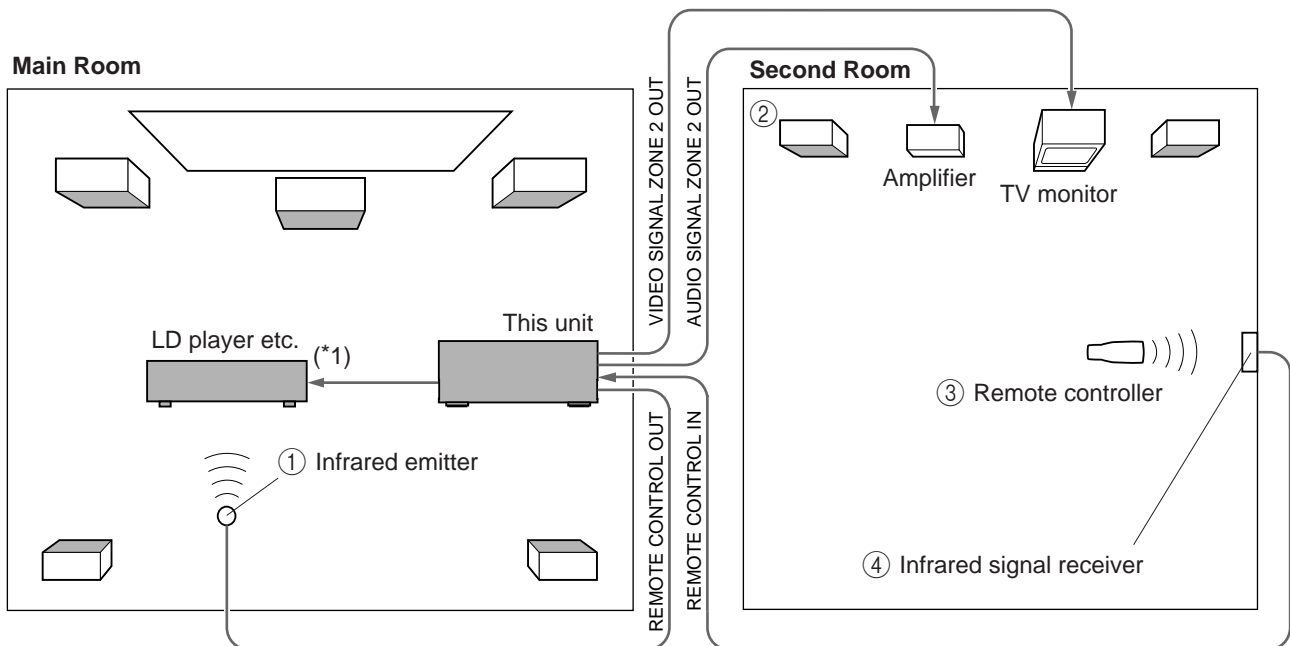

(*1): Some Yamaha models can be connected to this unit's REMOTE CONTROL OUT terminals. If you connect these units in series, the use of an infrared emitter may not be necessary.

Note

Since there are so many ways to connect and use this unit in a dual-room system, we recommend that you consult with a custom installation specialist for connections which will best meet your requirements.

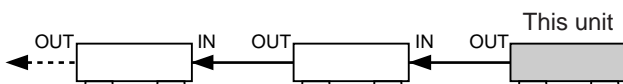

Up to 6 units can be connected in this connecting way.

■ Listening to (and watch) a source in the second room

- 1 Set the **VOLUME** control of the amplifier in the second room to “minimum”.
- 2 Select the source you will listen to and/or watch in the second room with the **REC OUT/ZONE 2** selector on the front panel of this unit in the main room.
- 3 Play back the source.
- 4 Increase the volume on the amplifier in the second room.

Notes

- If you want to listen to (and watch) the same source as that selected for the main room, set the **REC OUT/ZONE 2** selector to the “SOURCE” position.
- Signals of the source selected with the **REC OUT/ZONE 2** selector are also sent to the tape deck, VCR, etc. connected to this unit as signals to be recorded.

TROUBLESHOOTING

Refer to the chart below when this unit does not function properly. If the problem you are experiencing is not listed below or if the instruction below does not help, disconnect the power cord and contact your authorized YAMAHA dealer or service center.

General

Problem	Cause	What to Do
The unit fails to turn on when the STANDBY/ON switch is pressed, or turns into the standby mode suddenly soon after the power is turned on.	Power cord is not plugged in or is not completely inserted.	Firmly plug in the power cord.
	The IMPEDANCE SELECTOR switch on the rear panel is not set to either end.	Set the switch to either end when this unit is in the standby mode.
This unit does not work normally.	There is an influence of strong external noise (lightning, excessive static electricity, etc.) or a misoperation on this unit while using this unit.	Turn this unit into the standby mode and disconnect the AC power cord from the AC outlet. After about 30 seconds have passed, connect the power and operate this unit again.
No sound or no picture.	Incorrect output cord connections.	Connect the cords properly. If the problem persists, the cords may be defective.
	Appropriate input source is not selected.	Select the appropriate input source with the INPUT SELECTOR or the EXT. DECODER button.
	Speaker connections are not secure.	Secure the connections.
	Digital signals other than PCM audio and Dolby Digital (or DTS) encoded signals which this unit cannot reproduce are input to this unit by playing a CD-ROM etc.	Play a source whose signals this unit can reproduce.
No picture	There is no S video terminal connection between this unit and the TV, though S video signals are input to this unit.	Connect this unit's S VIDEO MONITOR OUT terminal to the TV's S video input terminal.
The sound suddenly goes off.	The protection circuit has been activated because of short circuit etc.	Turn this unit into the standby mode, and then turn on to reset the protection circuit.
	The SLEEP timer came on.	Cancel the SLEEP timer function.
Only one side speaker outputs the sound.	Incorrect setting of the BALANCE control.	Adjust it to the appropriate position.
	Incorrect cord connections.	Connect the cords properly. If the problem persists, the cords may be defective.
No sound from the effect speakers.	The EFFECT button is set off.	Press the EFFECT button to turn it on.
	A Dolby Surround (or DTS) decoding program is being used with material not encoded with Dolby Surround (or DTS).	Use a different sound field program.
No sound from the center speaker.	The function "1. CENTER SPEAKER" in the SET MENU mode is set to the "NONE" position.	Select the appropriate position.
	One of the DSP programs No. 1 to No. 5 is selected when the input signal of source is 2-channel stereo (analog/PCM).	Select another program.
	The input signals of source encoded with Dolby Digital or DTS do not have center channel signals.	Refer to the instructions for the source currently played.
Poor bass reproduction.	The function "4. LFE/BASS OUT" in the SET MENU mode is set in the SW or BOTH position, though your system does not include a subwoofer.	Select the MAIN position.
	Output mode selection for each channel (MAIN, CENTER or REAR) is improper.	Make output mode selections suitable for your speaker system.
Sound "hums".	Incorrect cord connections.	Firmly connect the audio plugs. If the problem persists, the cords may be defective.
	No connection from the turntable to the GND terminal.	Make the GND connection between the turntable and this unit.
The volume level is low while playing a record.	The record is being played on a turntable with an MC cartridge.	The player should be connected to the unit through the MC head amplifier.
The volume level cannot be increased, or sound is distorted.	The component connected to the TAPE/MD OUT terminals of this unit is turned off.	Turn on the power to the component.

Problem	Cause	What to Do
DSP parameters and some other settings on this unit cannot be changed.	The function "11. MEMORY GUARD" in the SET MENU mode is set to the "ON" position.	Set to the "OFF" position.
"INPUT DATA ERR" appears on the display and no sound is heard.	A nonstandardized source is played back, or the unit playing back a source is misoperating.	Check the source, or turn off the unit playing back the source and then turn on again.
The sound field cannot be recorded.	It is not possible to record the sound field on a tape deck connected to this unit's TAPE/MD OUT terminals.	
This unit does not operate properly.	The internal microcomputer has been frozen by an external electric shock (lightning, excessive static electricity, etc.) or power supply with low voltage.	Unplug the AC power cord from the wall AC outlet, and then plug in again after about one minute.
A source cannot be recorded by a tape deck or VCR connected to this unit.	The source unit is connected to this unit between digital terminals only.	Make additional connection between analog terminals.
Noise from nearby TV or tuner.	This unit is too close to the affected equipment.	Move the unit further away from the affected equipment.
The sound is degraded when listening with the headphones connected to the compact disc player or tape deck that is connected with this unit.	This unit is in the standby mode.	Turn the power to this unit on.

Remote controller

Problem	Cause	What to Do
The remote controller does not work.	The batteries of this remote controller are weak.	Replace the batteries with new ones and press the RESET button on the remote controller.
	The internal microcomputer "freezes".	Press the RESET button on the remote controller.
The remote controller does not function properly.	Wrong distance or angle.	The remote controller will function from a maximum range of 6 meters, no more than 30 degrees off-axis from the front panel.
	Direct sunlight or lighting (of an inverter type of fluorescent lamp etc.) is striking the remote control sensor of the main unit.	Change position of the main unit.
	The internal microcomputer "freezes".	Press the RESET button on the remote controller.
Learning cannot be made successfully. (The TRANSMIT/LEARN indicator does not light up or flash.)	The batteries of this remote controller and/or the other remote controller are weak.	Replace the batteries (and press the RESET button for this remote controller).
	The distance between the two remote controllers is too far or short.	Place the remote controllers at the proper distance.
	The signal coding or modulation of the other remote controller is not compatible with this remote controller.	Learning is not possible.
	Memory capacity is full.	Further learning is not possible without deleting unnecessary commands.
	The internal microcomputer "freezes".	Press the RESET button on the remote controller.
Continuous functions such as volume are learned, but operate only for a moment before stopping.	Learning process incomplete.	Be sure to press and hold the function key on the other remote controller until the TRANSMIT/LEARN indicator begins flashing slowly.

Tuner

	Problem	Cause	What to Do
FM	FM stereo reception is noisy.	Because of the characteristics of FM stereo broadcasts, this is limited to cases where the transmitter is too far away or the antenna input is poor.	Check the antenna connections. Try using a high quality directional FM antenna. Set the TUNING MODE button to the manual tuning mode.
	There is distortion and clear reception cannot be obtained even with a good FM antenna.	There is multipath interference.	Adjust antenna placement to eliminate multipath interference.
	A desired station cannot be tuned in with the automatic tuning method.	The station is too weak.	Use the manual tuning method. Use a high quality directional FM antenna.
	Previously preset stations can no longer be tuned in.	This unit has been unplugged for a long period.	Repeat the presetting procedure.
AM	A desired station cannot be tuned in with the automatic tuning method.	Weak signal or loose antenna connections.	Tighten the AM loop antenna connections and rotate it for best reception. Use the manual tuning method.
	There are continuous crackling and hissing noises.	Noises result from lightning, fluorescent lamps, motors, thermostats and other electrical equipment.	Use an outdoor antenna and a ground wire. This will help somewhat but it is difficult to eliminate all the noises.
	There are buzzing and whining noises (especially in the evening).	A television set is being used nearby.	Relocate this unit away from the TV.

<For China and General models only>

Although you make the operation for recalling a preset station, the station cannot be tuned in, or a station other than the preset one is tuned in.	Some memory of the preset stations was modified because the setting of the FREQUENCY STEP switch was changed after storing stations.	Repeat storing stations by following the preset tuning procedure.
---	--	---

When playing back a source encoded with DTS:

Problem	Cause	What to Do
A loud hissing noise is heard when you play back a source encoded with DTS.	The player which plays back the source is not connected to a digital audio signal input terminal of this unit.	The player must be connected to a digital audio signal input terminal of this unit besides analog audio signal terminal connections.
	The "ANALOG" input mode is selected on this unit.	Select a proper input mode on this unit to turn on the DTS decoder built into this unit.
A percussive noise is heard when you begin playing back a source encoded with DTS.	If the "AUTO" input mode is selected, depending on some sources, there may be a case that a noise is heard while this unit is identifying the format of input signal.	Set the input mode of the currently selected input source to "DTS".
No sound is heard when you play back a source encoded with DTS, even though the "AUTO" or "DTS" input mode is selected on this unit.	The DTS decoder built into this unit does not function because the player has a digital volume control and it is set at a position other than "maximum", "neutral" or "ineffective".	Set the player's digital volume control at the maximum, neutral or ineffective position.
No sound is heard when you play back an MD onto which you have recorded a source encoded with DTS.	A source encoded with DTS cannot be recorded onto an MD.	/
No sound is heard when you play back a DAT onto which you have recorded a source encoded with DTS.	Depending on a DAT deck, a source encoded with DTS cannot be recorded onto a DAT.	
No sound is heard when you play back a source (CD etc.) even though the currently selected input mode is "AUTO".	In the "AUTO" mode, DTS-decoding mode cannot be changed to the normal (PCM) digital signal input mode automatically.	Press the INPUT MODE button on the front panel or the input selector button (for the currently selected source) on the remote controller so that "PCM" appears on the display.

Notes

- It is necessary to use a DTS decoder to play back a source encoded with DTS, so the player which plays back a source must be connected to a digital audio input terminal of this unit in the way described in this manual. If this connection is not made or only a D-to-A converter is used without using a DTS decoder, when you play back a source, only a loud hiss noise will be heard.
- If you make a search (or skip etc.) operation while playing back a source encoded with DTS, the "dts" indicator goes out from the display. This is because this unit automatically changes the DTS-decoding mode to the standard (PCM) digital signal input mode to prevent a noise from being output.
- A source encoded with DTS cannot be recorded onto analog audio and video tapes, and also, an analog tape recorded with a source encoded with DTS cannot be played back.
The same result is obtained for MDs and DATs (depending on a DAT deck used for recording and/or playback).

SPECIFICATIONS

AUDIO SECTION

Minimum RMS Output Power Per Channel
(When both channels are driven)
MAIN L/R (20 Hz to 20 kHz, 0.04%
THD, 8 ohms) 100W+100W
CENTER (20 Hz to 20 kHz, 0.07%
THD, 8 ohms) 100W
REAR L/R (20 Hz to 20 kHz, 0.07%
THD, 8 ohms) 100W+100W

Maximum Power [China and General
models only]
1 kHz, 10% THD, 8 ohms
(When both channels are driven)
MAIN L/R 135W+135W
CENTER 135W
REAR L/R 135W+135W

Dynamic Power Per Channel
(by IHF Dynamic Headroom Measuring Method)
[U.S.A., Canada, China and General models
only]
MAIN L/R (8 ohms/6 ohms/4 ohms/2 ohms)
(When both channels are driven)
..... 130W/160W/200W/240W

Dynamic Headroom
[U.S.A., Canada, China and General models
only]
MAIN L/R (8 ohms) 1.13 dB

DIN Standard Output Power Per Channel
[Singapore model only]
MAIN L/R (1 kHz, 0.7% THD, 4 ohms)
(When both channels are driven) 150W

IEC Power [Singapore model only]
MAIN L/R (1 kHz, 0.015% THD, 8 ohms)
(When both channels are driven) 105W

Power Band Width (20 Hz to 20 kHz)
8 ohms, 50W, 0.08% THD
(When both channels are driven)
..... 10 Hz to 50 kHz

Damping Factor
MAIN L/R (20 Hz to 20 kHz, 8 ohms)
..... More than 160

Input Sensitivity/Impedance (100W/8 ohms)
CD/TAPE-MD/DVD-LD/TV-DBS/VCR 1
/VCR 2/VIDEO AUX 150 mV/47 k-ohms
PHONO MM 2.5 mV/47 k-ohms

Maximum Input Signal (1 kHz, 0.05% THD)
CD/TAPE-MD/DVD-LD/TV-DBS/VCR 1
/VCR 2/VIDEO AUX (EFFECT ON)
..... 2.3V or more
PHONO MM 110 mV or more

Output Level/Impedance
REC OUT 150 mV/1.0 k-ohms
PRE OUT
MAIN, CENTER, REAR
..... 2.6V/1.1 k-ohms
SUBWOOFER (MAIN SP: SMALL)
(EFFECT OFF) 4.0V/1.5 k-ohms
ZONE 2 OUT 1.0V/1.5 k-ohms

Headphone Jack Rated Output/Impedance
Output Level
CD/TAPE-MD/DVD-LD/TV-DBS/VCR 1
/VCR 2/VIDEO AUX Input: 1 kHz,
150 mV, RL=8 ohms 0.5V
Impedance 440 ohms

Frequency Response (20 Hz to 20 kHz)
CD/TAPE-MD/DVD-LD/TV-DBS/VCR 1
/VCR 2/VIDEO AUX to MAIN L/R SP OUT
..... 0±0.5 dB

RIAA Equalization Deviation
(20 Hz to 20 kHz)
PHONO MM 0±0.5 dB

Total Harmonic Distortion (20 Hz to 20 kHz)
CD/TAPE-MD/DVD-LD/TV-DBS/VCR 1
/VCR 2/VIDEO AUX (EFFECT OFF) to SP
OUT (MAIN L/R), 50W/8 ohms
..... Less than 0.025%
PHONO MM to REC OUT, 3V
..... Less than 0.01%

Signal-to-Noise Ratio (IHF-A Network)
CD/TAPE-MD/DVD-LD/TV-DBS/VCR 1
/VCR 2/VIDEO AUX (Input Shorted)
(EFFECT OFF) More than 96 dB
PHONO MM (Input Shorted 5 mV)
(EFFECT OFF) More than 86 dB

Residual Noise (IHF-A Network)
MAIN L/R SP OUT Less than 170 µV

Channel Separation (Vol. -30 dB)
CD/TAPE-MD/DVD-LD/TV-DBS/VCR 1
/VCR 2/VIDEO AUX Input 5.1 k-ohms
Shorted (EFFECT OFF)
1 kHz/10 kHz More than 60 dB/45 dB
PHONO MM Input Shorted (EFFECT OFF)
1 kHz/10 kHz More than 60 dB/55 dB

Tone Control Characteristics
Bass
Boost/Cut ±10 dB (50 Hz)
Turnover frequency 350 Hz
Treble
Boost/Cut ±10 dB (20 kHz)
Turnover frequency 3.5 kHz

Bass Extension (MAIN L/R)
..... +6 dB (50 Hz)

Filter Characteristics
MAIN L/R, CENTER, REAR L/R
(MAIN, CENTER, REAR SP: SMALL)
(H.P.F.) fc = 90 Hz, 12 dB/oct.
SUBWOOFER (L.P.F.)
..... fc = 90 Hz, 18 dB/oct.

Gain Tracking Error (0 to -60 dB)
MAIN L/R 3 dB or less

Audio Muting -∞

VIDEO SECTION

Video Signal Type
[U.S.A. and Canada models] NTSC
[Australia and Singapore models] PAL
[China and General models] NTSC/PAL

Video Signal Level 1 Vp-p/75 ohms

S-Video Signal Level
Y 1 Vp-p/75 ohms
C 0.286 Vp-p/75 ohms

Maximum Input Level More than 1.5 Vp-p

Signal-to-Noise Ratio More than 50 dB

Monitor Out Frequency Response
..... 5 Hz to 10 MHz, -3 dB

FM SECTION

Tuning Range
[U.S.A. and Canada models]
..... 87.5 to 107.9 MHz
[Australia, China, Singapore and General
models] 87.5 to 108.0 MHz

50 dB Quieting Sensitivity (IHF, 75 ohms,
100% mod., 1 kHz)
[U.S.A., Canada, China and General
models only]
Mono 1.6 µV (15.3 dBf)
Stereo 23 µV (38.5 dBf)

Usable Sensitivity (75 ohms)
[Australia and Singapore models only]
DIN, Mono (S/N 26 dB) 0.9 µV
DIN, Stereo (S/N 46 dB) 28 µV

Alternate Channel Selectivity (±400 kHz)
[U.S.A., Canada, China and General
models only] 75 dB

Selectivity (two signals, 40 kHz Dev. ±300
kHz)
[Australia and Singapore models only]
..... 55 dB

Signal-to-Noise Ratio
(IHF) Mono/Stereo
[U.S.A., Canada, China and General
models]81 dB/75 dB
(DIN-Weighted, 40 kHz Dev.) Mono/Stereo
[Australia and Singapore models]
.....75 dB/69 dB

Harmonic Distortion (1 kHz)
[U.S.A., Canada, China and General models]
Mono/Stereo0.1/0.2%
[Australia and Singapore models]
Mono/Stereo (40 kHz Dev.)0.1/0.2%

Stereo Separation (1 kHz)
[U.S.A., Canada, China and General models]
.....48 dB
[Australia and Singapore models
(40 kHz Dev.)]48 dB

Frequency Response
20 Hz to 15 kHz0±1 dB

AM SECTION

Tuning Range
[U.S.A., Canada, China and General models]
..... 530 to 1,710 kHz
[Australia and Singapore models]
.....531 to 1,611 kHz

Usable Sensitivity300 µV/m

Signal-to-Noise Ratio52 dB

AUDIO SECTION

Output Level/Impedance
FM (100% mod., 1 kHz)
[U.S.A., Canada, China and General
models]550 mV/1.0 k-ohms
[Australia and Singapore models
(40 kHz Dev.)]550 mV/1.0 k-ohms
AM (30% mod., 1 kHz)150 mV/1.0 k-ohms

GENERAL

Power Supply
[U.S.A. and Canada models]
..... AC 120V/60 Hz
[Australia model] AC 240V/50 Hz
[Singapore model] AC 230V/50 Hz
[China and General models]
..... AC 110/120/220/240V, 50/60 Hz

Power Consumption
[U.S.A., Australia, China, Singapore and
General models] 400W
[Canada model]400W/540 VA

Maximum Power Consumption
[General model only]750W

AC Outlets
2 SWITCHED OUTLETS
[U.S.A., China, Singapore and General
models] 100W max. total
[Canada model]100W/1.0A max. total
1 SWITCHED OUTLET
[Australia model] 100W max.

Dimensions (W x H x D)
..... 435 x 171 x 391 mm
(17-1/8" x 6-3/4" x 15-3/8")

Weight 14.1 kg (31.1 lbs.)

AccessoriesRemote controller
Batteries
User function stickers
AM loop antenna
Indoor FM antenna
Antenna adapter
(U.S.A. and Canada models only)

* Specifications are subject to change without notice.



YAMAHA ELECTRONICS CORPORATION, USA 6660 ORANGETHORPE AVE., BUENA PARK, CALIF. 90620, U.S.A.
YAMAHA CANADA MUSIC LTD. 135 MILNER AVE., SCARBOROUGH, ONTARIO M1S 3R1, CANADA
YAMAHA ELECTRONIK EUROPA G.m.b.H. SIEMENSSTR. 22-34, 25462 RELINGEN BEI HAMBURG, FR. OF GERMANY
YAMAHA ELECTRONIQUE FRANCE S.A. RUE AMBROISE CROIZAT BP70 CROISSY-BEAUBOURG 77312 MARNE-LA-VALLEE CEDEX02, FRANCE
YAMAHA ELECTRONICS (UK) LTD. YAMAHA HOUSE, 200 RICKMANSWORTH ROAD WATFORD, HERTS WD1 7JS, ENGLAND
YAMAHA SCANDINAVIA A.B. J A WETTERGRENS GATA 1, BOX 30053, 400 43 VÄSTRA FRÖLUNDA, SWEDEN
YAMAHA MUSIC AUSTRALIA PTY, LTD. 17-33 MARKET ST., SOUTH MELBOURNE, 3205 VIC., AUSTRALIA

YAMAHA CORPORATION
Printed in Malaysia ❁ V303930